

This manual describes the function of the Binary Inputs BE/S.

Subject to changes and errors excepted.

Exclusion of liability:

Despite checking that the contents of this document match the hardware and software, deviations cannot be completely excluded. We therefore cannot accept any liability for this. Any necessary corrections will be inserted in new versions of the manual.

Please inform us of any suggested improvements.

Contents

	Page
1	General 4
1.1	Product and functional overview 5
2	Device technology 6
2.1	Binary Input with with manual operation, 4-fold, 230 V AC/DC, MDRC 6
2.1.1	Technical data 6
2.1.2	Circuit diagram 7
2.1.3	Dimension drawing 7
2.1.4	Assembly and installation 8
2.2	Binary Input with manual operation, 4-fold, 24 V AC/DC, MDRC 9
2.2.1	Technical data 9
2.2.2	Circuit diagram 10
2.2.3	Dimension drawing 10
2.2.4	Assembly and installation 11
2.3	Binary Input with manual operation, 4-fold, contact scanning, MDRC 12
2.3.1	Technical data 12
2.3.2	Circuit diagram 13
2.3.3	Dimension drawing 13
2.3.4	Assembly and installation 14
2.4	Binary Input with manual operation, 8-fold, 230 V AC/DC, MDRC 15
2.4.1	Technical data 15
2.4.2	Circuit diagram 16
2.4.3	Dimension drawing 16
2.4.4	Assembly and installation 17
2.5	Binary Input with manual operation, 8-fold, 24 V AC/DC, MDRC 18
2.5.1	Technical data 18
2.5.2	Circuit diagram 19
2.5.3	Dimension drawing 19
2.5.4	Assembly and installation 20
2.6	Binary input with manual operation, 8-fold, contact scanning, MDRC 21
2.6.1	Technical data 21
2.6.2	Circuit diagram 22
2.6.3	Dimension drawing 22
2.6.4	Assembly and installation 23

Contents

	Page
3	Commissioning 24
3.1	Overview 24
3.1.1	Conversion of earlier user programs 25
3.2	Parameters 26
3.2.1	General parameters 26
3.2.1.1	Parameter window "General" 26
3.2.1.2	Parameter window "Manual Operation" 29
3.2.1.3	Parameter window "Enable/release manual operation button" 32
3.2.1.4	Parameter window "Channel LED display" 33
3.2.1.5	Communication objects "General" 34
3.2.1.6	Parameter window "Channel A, general" 35
3.2.2	Switch sensor / fault signal input operating mode 36
3.2.2.1	Parameter window "Channel A, general" 36
3.2.2.2	Parameter window "Channel A, switch sensor" 40
3.2.2.3	Parameter window "Channel A, switch sensor" 42
3.2.3	Fault signal input operating mode 43
3.2.3.1	Parameter window "Channel A, general" 43
3.2.3.2	Parameter window "Channel A, switch sensor" operating mode for a fault signal input 48
3.2.3.3	Communication objects "Channel A" 50
3.2.3.4	Communication objects "Channel B to H" 51
3.2.4	Switch/dimming sensor operating mode 52
3.2.4.1	Parameter window "Channel A, general" 52
3.2.4.2	Parameter window "Channel A, switch/dimming sensor" 53
3.2.4.3	Communication objects "Channel A" 56
3.2.4.4	Communication objects "Channel B to H" 57
3.2.5	Shutter sensor operating mode 58
3.2.5.1	Parameter window "Channel A, general" 58
3.2.5.2	Parameter window "Channel A, shutter sensor" 59
3.2.5.3	Communication objects "Channel A" 62
3.2.5.4	Communication objects "Channel B to H" 63
3.2.6	Operating mode value/forced operation 64
3.2.6.1	Parameter window "Channel A, general" 64
3.2.6.2	Parameter window "Channel A, value/forced operation value X" 69
3.2.6.3	Communication objects "Channel A" 71
3.2.6.4	Communication objects "Channel B to H" 72
3.2.7	Control scene operating mode 73
3.2.7.1	Parameter window "Channel A, general" 74
3.2.7.2	Parameter window "Channel A, scene part X" 76
3.2.7.3	Communication objects "Channel A" 77
3.2.7.4	Communication objects "Channel B to H" 79
3.2.8	Switching sequence operating mode 80
3.2.8.1	Parameter window "Channel A, general" 80
3.2.8.2	Parameter window "Channel A, switching sequence" 82
3.2.8.3	Communication objects "Channel A" 85
3.2.8.4	Communication objects "Channel B to H" 86

Contents

	Page
3.2.9	Multiple operation operating mode 87
3.2.9.1	Parameter window "Channel A, general" 87
3.2.9.2	Parameter window "Channel A, multiple operation" 89
3.2.9.3	Communication objects "Channel A" 91
3.2.9.4	Communication objects "Channel B to H" 92
3.2.10	Counter operating mode 93
3.2.10.1	Counting pulses 93
3.2.10.2	Behaviour of the counter levels after a download 94
3.2.10.3	Behaviour of the counter levels after bus voltage failure . 94
3.2.10.4	Peculiarities between the main counter and differential counter 94
3.2.10.5	Parameter window "Channel A, general" 95
3.2.10.6	Parameter window "Channel A, main counter" 97
3.2.10.7	Parameter window "Channel A, differential counter" 99
3.2.10.8	Communication objects "Channel A, main counter" 102
3.2.10.9	Communication objects "Channel B to H main counter" 103
3.2.10.10	Communication objects "Channel A main and differential counter" 104
3.2.10.11	Communication objects "Channel B to H main and differential counter" 106
4	Planning and application 107
4.1	Operation with central function (light switching) 107
4.2	Fault signal input 108
4.3	Operation of lighting (dim lighting) 111
4.4	Operation of shutters 112
4.5	Control scene 114
4.6	Switching sequence (switching of luminaires) 115
4.7	Multiple button operation (switching of luminaires) 117
4.8	Counting of power values 118
A	Appendix I
A.1	Scope of delivery I
A.2	4 bit dimming command I
A.3	Gray code II
A.4	8-bit-scene key table III
A.5	Directory of drawings IV
A.6	Directory of tables VI
A.7	Index VII
A.8	Ordering information VIII
A.9	Notes IX

1 General

The comprehensive range of functions in modern buildings with EIB / KNX should be as easy and as intuitive to operate as possible for the user. At the same time, clear and comfortable operating features are particularly significant for the feeling of well-being within buildings.

The Binary Input fulfils the individual demands in functional buildings as well as in residential buildings. In the same way, system planners are provided with varied application possibilities with regard to the implementation of functions.

This manual provides you with detailed technical information relating to the Binary Inputs, installation, programming and explains the use of the Binary Inputs using examples.

This manual is divided into the following sections:

- Chapter 1 General
- Chapter 2 Device technology
- Chapter 3 Commissioning
- Chapter 4 Planning and application
- Appendix

1.1 Product and functional overview

The Binary Inputs BE/S are modular installation devices for installation in the distribution board. The connection to the bus is implemented via a bus connection terminal on the front of the device. The assignment of the physical addresses as well as the parameterisation is carried out with ETS2 from version 1.3a or ETS3 from version V1.0.

The devices feature one manual operation button (9) per channel.

The inputs can be operated manually with this button.

Connection of conventional push buttons, switches or floating contacts is not necessary during commissioning due to this button. The devices are powered via the ABB i-bus® and do not require an additional power supply.

The Binary Inputs serve as interfaces for operation of EIB / KNX systems via conventional buttons/switches or for coupling of binary signals (signal contacts).

The binary signals are processed in the application programs **Binary 4f 230M/1, Binary 4f 24M/1, Binary 4f 20M/1, Binary 8f 230M/1, Binary 8f 24M/1 and Binary 8f 20M/1.**

The device features comprehensive and clearly arranged functionality and permits usage in the most differing fields of application.

The following list provides an overview:

- Switching and dimming of lighting (also 1 button operation)
- Operation of blinds and shutters (also 1 button operation)
- Sending of values e.g. temperature values
- Control and storing of lightscenes
- Control of different loads with multiple operation
- Operation of several loads in a defined switching sequence
- Counting of pulses and operations
- Reading out of floating contacts

Each input can take over any of the functions described above.

2 Device technology

2.1 Binary Input with manual operation, 4-fold, 230 V AC/DC, MDRC



2CDC 071 594 F0004

Fig. 1: BE/S 4.230.1

The 4-fold Binary Input BE/S 4.230.1 with manual operation is a rail mounted device for insertion in the distribution board. The device is suitable for reading out 0...265 V AC/DC signals. Inputs A and B are independent of inputs C and D.

Buttons on the front of the device can be used to simulate the input state. The status of the inputs are displayed by yellow LEDs.

The device is ready for operation after connection to the bus voltage. The Binary Input is parameterised via ETS2 V1.3a or higher. The connection to the bus is established using the front side bus connection terminal.

2.1.1 Technical data

Power supply	– Bus voltage – Current consumption, bus – Power consumption – Leakage loss, bus	21 ... 32 V DC < 10 mA Max. 1.8W Max. 200 mW
Inputs	– Number – Permitted voltage range U_n – Input current I_n – Signal level for 0-signal – Signal level for 1-signal – Permitted cable lengths	4 0...265 V AC/DC Max. 2 mA 0...120 V AC/DC 180...265 V AC/DC ≤ 100 m with 1.5 mm ²
Connections	– EIB / KNX – Inputs	via bus connection terminal, without screws using screw terminals
Connection terminals	– Screw terminals – Tightening torque	0.2 ... 2.5 mm ² finely stranded 0.2 ... 4.0 mm ² , single-core Max. 0.6 Nm
Operating and display elements	– Programming LED – Programming button – Channel LED – Manual operation button – Manual/Automatic LED (Man.) – Manual/Automatic button (Man.)	for assignment of the physical address for assignment of the physical address 1 LED per channel for display of the input state 1 button per channel for changing the input state 1 LED for display of the manual/ automatic mode states 1 button for switchover of manual and automatic mode
Enclosure	– IP 20	to DIN EN 60 529
Safety class	– II	to DIN EN 61 140
Temperature range	– Operation – Storage – Transport	– 5 °C...+ 45 °C – 25 °C...+ 55 °C – 25 °C...+ 70 °C
Environment conditions	– max. humidity	93%, without bedewing
Design	– Modular installation device (MDRC) – Dimensions – Mounting width in space units – Mounting depth	Modular installation device, ProM 90 x 36 x 67.5 mm (H x W x D) 2, 2 modules at 18 mm 67.5 mm
Installation	– On 35 mm mounting rails to DIN EN 60 715	to DIN EN 60 715
Mounting position	– as required	
Weight	– 0.1 kg	
Housing/colour	– Plastic housing, grey	
Approvals	– EIB / KNX to EN 50 090-1, -2 certificate	certificate
CE mark	– in accordance with the EMC guideline and low voltage guideline	

Table 1: Technical data BE/S 4.230.1

Application program	Max. number of communication objects	Max. number of group addresses	Max. number of associations
Binary 4f 230M/1	43	254	254

Table 2: Application program BE/S 4.230.1

Note: The programming requires EIB Software Tool ETS2 V1.3a or higher. If ETS3 is used a ".VD3" type file must be imported. The application program is available in the ETS2 / ETS3 at ABB/Input/Binary Input 4-fold.

2.1.2 Circuit diagram

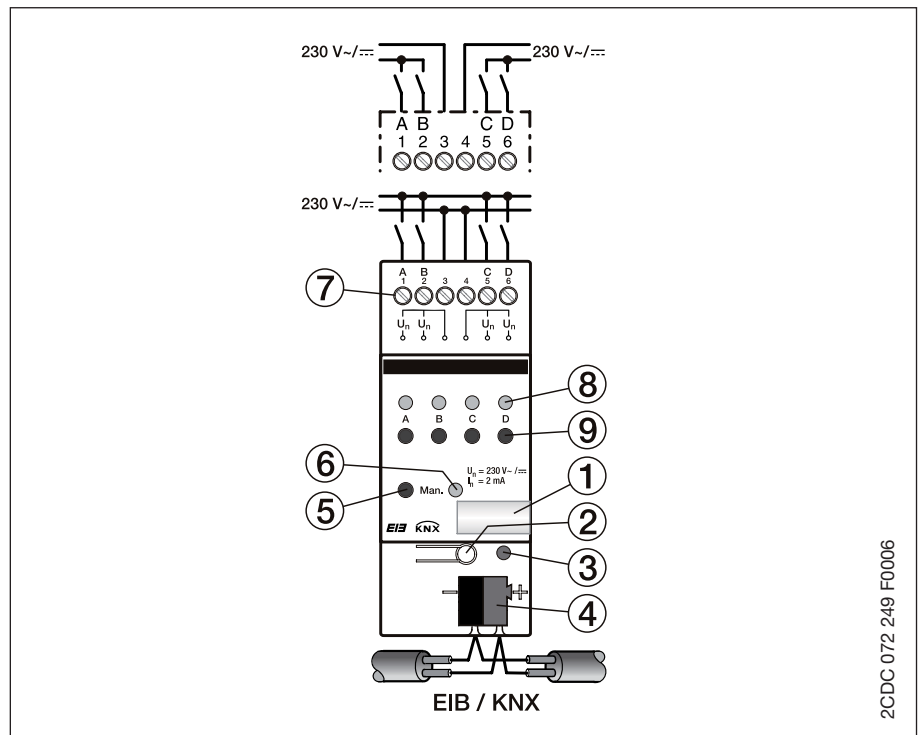

Fig. 2: Circuit diagram of BE/S 4.230.1

- 1 Label carriers
- 2 Programming button
- 3 Programming LED
- 4 Bus connection terminal
- 5 Manual/Automatic button
- 6 Manual/Automatic LED
- 7 Connection terminals
- 8 Channel LED
- 9 Manual operation button

2.1.3 Dimension drawing

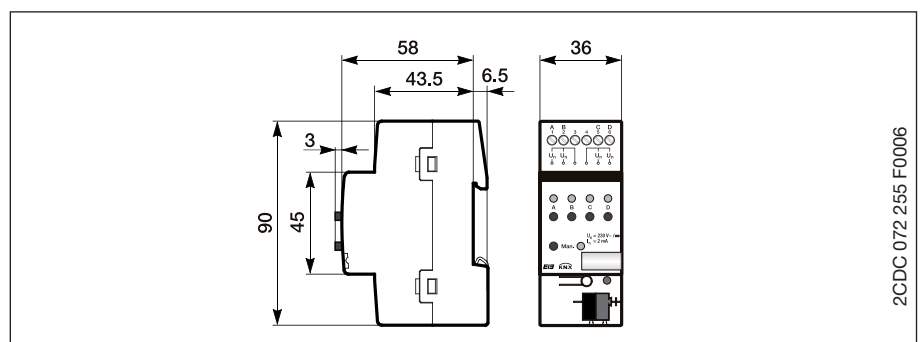

Fig. 3: Dimension drawing BE/S 4.230.1

2CDC 072 249 F0006

2CDC 072 255 F0006

2.1.4 Assembly and installation

The Binary Input is a modular installation device for fast installation in the distribution board on 35 mm mounting rails to DIN EN 60 715.

The electrical connection is implemented using screw terminals. The connection to the bus is implemented using the supplied bus connection terminal.

The device is ready for operation after connection to the bus voltage. Accessibility of the devices for the purpose operation, testing, visual inspection, maintenance and repair must be provided (conform to DIN VDE 0100-520).

Commissioning requirements

To put the Binary Input BE/S 4.230.1 into operation, you require a PC with the Engineering Tool Software ETS2 from V1.3a onwards in conjunction with an RS232 interface or a USB interface. The device is ready for operation after connection to the bus voltage.

The installation and commissioning may only be carried out by electrical specialists. The appropriate norms, guidelines, regulations and specifications should be observed when planning and setting up electrical installations.

- The device should be protected from damp, dirt and damage during transport, storage and operation.
- The device should not be operated outside the specified technical data!
- The device should only be operated in a closed housing (distribution board)!

Supplied state

The Binary Input is supplied with the physical address 15.15.255. The **Binary 4f 230M/1** user program is preinstalled. Hence, only group addresses and parameters must be loaded during commissioning. The entire application can be reloaded as required. A longer downtime may result if the application program is changed or after a discharge.

Assignment of the physical address

The assignment and programming of the physical address is carried out in the ETS.

Cleaning

If devices become dirty, they can be cleaned using a dry cloth. Should a dry cloth not remove the dirt, they can be cleaned using a slightly damp cloth and soap solution. Corrosive materials or solutions should never be used.

Maintenance

The device is maintenance-free. No repairs should be carried out by unauthorised personnel if damage occurs (e.g. during transport or storage). The warranty expires if the device is opened.

2.2 Binary Input with manual operation, 4-fold, 24 V AC/DC, MDRC



Fig. 4: BE/S 4.24.1

The 4-fold Binary Input BE/S 4.24.1 with manual operation is a rail mounted device for insertion in the distribution board. The device is suitable for reading out 0...32 V AC/DC signals. Inputs A and B are independent of inputs C and D.

Buttons on the front of the device can be used to simulate the input state. The status of the inputs are displayed by yellow LEDs.

The device is ready for operation after connection to the bus voltage. The Binary Input is parameterised via ETS2 V1.3a or higher. The connection to the bus is established using the front side bus connection terminal.

2.2.1 Technical data

Power supply	– Bus voltage – Current consumption, bus – Power consumption – Leakage loss, bus	21 ... 32 V DC < 10 mA Max. 600 mW Max. 200 mW
Inputs	– Number – Permitted voltage range U_n – Input current I_n – Signal level for 0-signal – Signal level for 1-signal – Permitted cable lengths	4 0...32 V AC/DC Max. 5 mA 0...4 V AC/DC 9...32 V AC/DC ≤ 100 m bei 1.5 mm ²
Connections	– EIB / KNX – Inputs	via screw terminals, without screws via bus connection terminal
Connection terminals	– Screw terminals – Tightening torque	0.2 ... 2.5 mm ² finely stranded 0.2 ... 4.0 mm ² single core Max. 0.6 Nm
Operating and display elements	– Programming LED – Programming button – Channel LED – Manual operation button – Manual/Automatic LED (Man.) – Manual/Automatic button (Man.)	for assignment of the physical address for assignment of the physical address 1 LED per channel for display of the input state 1 button per channel for changing the input state 1 LED for display of the manual/automatic mode states 1 button for switchover of manual and automatic mode
Enclosure	– IP 20	to DIN EN 60 529
Safety class	– II	to DIN EN 61 140
Temperature range	– Operation – Storage – Transport	– 5 °C...+ 45 °C – 25 °C...+ 55 °C – 25 °C...+ 70 °C
Environment conditions	– max. humidity	93%, without bedewing
Design	– Modular installation device (MDRC) – Dimensions – Mounting width in space units – Mounting depth	Modular installation device, ProM 90 x 36 x 67.5 mm (H x W x D) 2, 2 modules at 18 mm 67.5 mm
Installation	– On 35 mm mounting rails	to DIN EN 60 715
Mounting position	– as required	
Weight	– 0.1 kg	
Housing/colour	– Plastic housing, grey	
Approvals	– EIB / KNX to EN 50 090-1, -2	certificate
CE mark	– in accordance with the EMC guideline and low voltage guideline	

Table 3: Technical data BE/S 4.24.1

Application program	Max. number of communication objects	Max. number of group addresses	Max. number of associations
Binary 4f 24M/1	43	254	254

Table 4: Application program BE/S 4.24.1

Note: The programming requires EIB Software Tool ETS2 V1.3a or higher. If ETS3 is used a “.VD3” type file must be imported. The application program is available in the ETS2 /ETS3 at ABB/Input/Binary Input 4-fold.

2.2.2 Circuit diagram

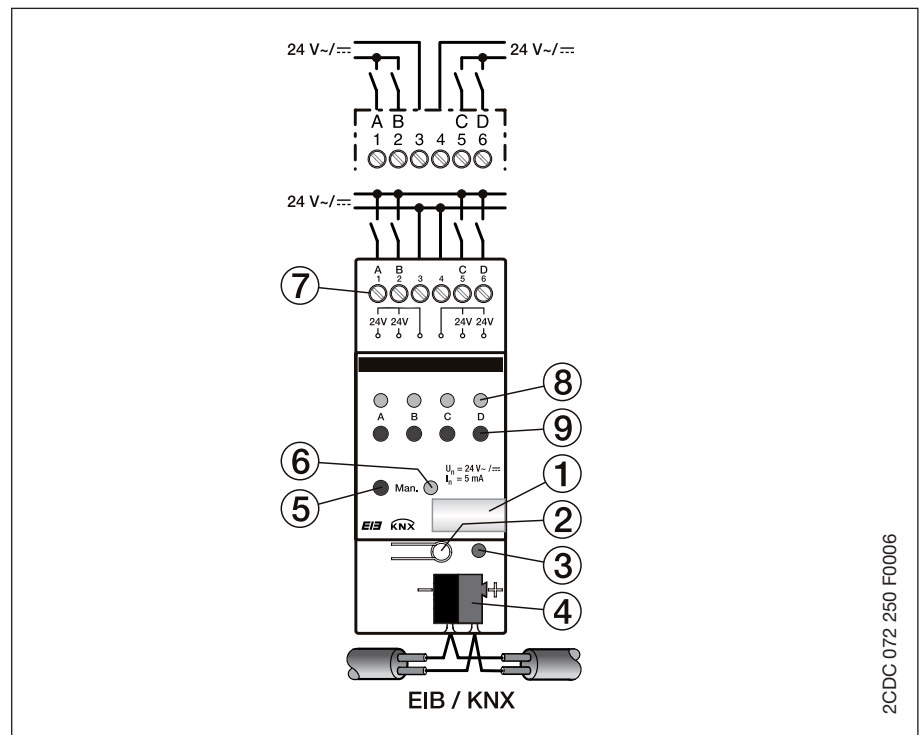

Fig. 5: Circuit diagram of BE/S 4.24.1

- 1 Label carriers
- 2 Programming button
- 3 Programming LED
- 4 Bus connection terminal
- 5 Manual/Automatic button
- 6 Manual/Automatic LED
- 7 Connection terminals
- 8 Channel LED
- 9 Manual operation button

2.2.3 Dimension drawing

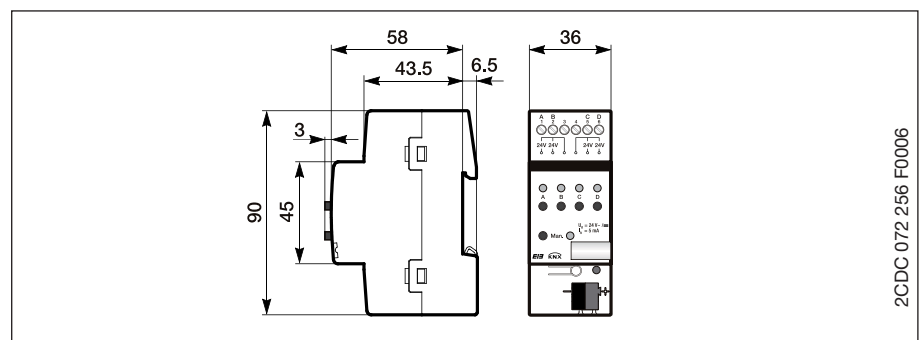

Fig. 6: Circuit diagram of BE/S 4.24.1

2.2.4 Assembly and installation

The Binary Input is a modular installation device for fast installation in the distribution board on 35 mm mounting rails to DIN EN 60 715.

The electrical connection is implemented using screw terminals. The connection to the bus is implemented using the supplied bus connection terminal.

The device is ready for operation after connection to the bus voltage. Accessibility of the devices for the purpose operation, testing, visual inspection, maintenance and repair must be provided (conform to DIN VDE 0100-520).

Commissioning requirements

To put the Binary Input BE/S 4.24.1 into operation, you require a PC with the Engineering Tool Software ETS2 from V1.3a onwards in conjunction with an RS232 interface or a USB interface. The device is ready for operation after connection to the bus voltage.

The installation and commissioning may only be carried out by electrical specialists. The appropriate norms, guidelines, regulations and specifications should be observed when planning and setting up electrical installations.

- The device should be protected from damp, dirt and damage during transport, storage and operation.
- The device should not be operated outside the specified technical data!
- The device should only be operated in a closed housing (distribution board)!

Supplied state

The Binary Input is supplied with the physical address 15.15.255. The **Binary 4f 24M/1** user program is preinstalled. Hence, only group addresses and parameters must be loaded during commissioning. The entire application can be reloaded as required. A longer downtime may result if the application program is changed or after a discharge.

Assignment of the physical address

The assignment and programming of the physical address is carried out in the ETS.

Cleaning

If devices become dirty, they can be cleaned using a dry cloth. Should a dry cloth not remove the dirt, the devices can be cleaned using a slightly damp cloth and soap solution. Corrosive materials or solutions should never be used.

Maintenance

The device is maintenance-free. No repairs should be carried out by unauthorised personnel if damage occurs (e.g. during transport or storage). The warranty expires if the device is opened.

2.3 Binary Input with manual operation, 4- fold, contact scanning, MDRC



Fig. 7: BE/S 4.20.1

The 4-fold Binary Input BE/S 4.20.1 with manual operation is a rail mounted device for insertion in the distribution board. The device is suitable for reading out of floating contacts. The pulsed polling voltage is generated internally.

Buttons on the front of the device can be used to simulate the input state. The status of the inputs are displayed by yellow LEDs.

The device is ready for operation after connection to the bus voltage. The Binary Input is parameterised via ETS2 V1.3a or higher. The connection to the bus is established using the front side bus connection terminal.

2.3.1 Technical data

Power supply	– Bus voltage – Current consumption, bus – Leakage loss, bus	21 ... 32 V DC < 10 mA Max. 200 mW
Inputs	– Number – Polling voltage U_n – Sensing current I_n – Sensing current I_n when switching on – Permitted cable lengths	4 32 V, pulsed 0.1 mA Max. 355 mA ≤ 100 m bei 1.5 mm ²
Connections	– EIB / KNX – Inputs	via bus connection terminal, without screws using screw terminals
Connection terminals	– Screw terminals – Tightening torque	0.2 ... 2.5 mm ² finely stranded 0.2 ... 4.0 mm ² single-core Max. 0.6 Nm
Operating and display elements	– Programming LED – Programming button – Channel LED – Manual operation button – Manual/Automatic LED (Man.) – Manual/Automatic button (Man.)	for assignment of the physical address for assignment of the physical address 1 LED per channel for display of the input state 1 button per channel for changing the input state 1 LED for display of the manual/automatic mode states 1 button for switchover of manual and automatic mode
Enclosure	– IP 20	to DIN EN 60 529
Safety class	– II	to DIN EN 61 140
Temperature range	– Operation – Storage – Transport	– 5 °C...+ 45 °C – 25 °C...+ 55 °C – 25 °C...+ 70 °C
Environment conditions	– max. humidity	93%, without bedewing
Design	– Modular installation device (MDRC) – Dimensions – Mounting width in space units – Mounting depth	Modular installation device, ProM 90 x 36 x 67.5 mm (H x W x D) 2, 2 modules at 18 mm 67.5 mm
Installation	– On 35 mm mounting	to DIN EN 60 715
Mounting position	– as required	
Weight	– 0.1 kg	
Housing /colour	– Plastic housing, grey	
Approvals	– EIB / KNX nach EN 50 090-1, -2	Certification
CE mark	– in accordance with the EMC guideline and low voltage guideline	

Table 5: Technical data BE/S 4.20.1

Application program	Max. number of communication objects	Max. number of group addresses	Max. number of associations
Binary 4f 20M/1	43	254	254

Table 6: Application program BE/S 4.20.1

Note: The programming requires EIB Software Tool ETS2 V1.3a or higher. If ETS3 is used a “.VD3” type file must be imported. The application program is available in the ETS2 / ETS3 at ABB/Input/Binary Input 4-fold.

2.3.2 Circuit diagram

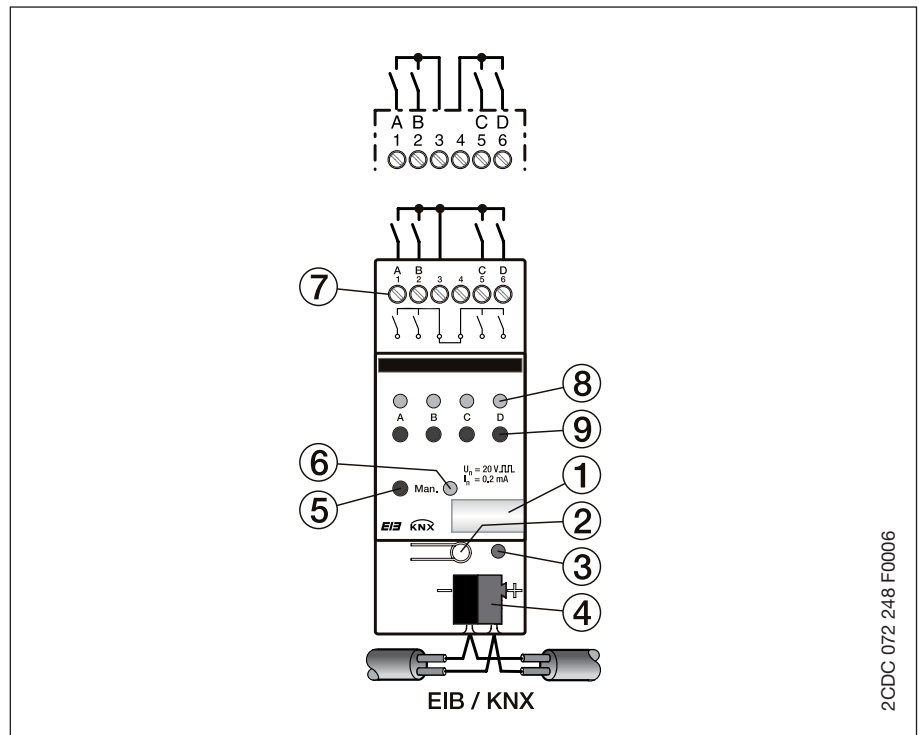

Fig. 8: Circuit diagram BE/S 4.20.1

- 1 Label carriers
- 2 Programming button
- 3 Programming LED
- 4 Bus connection terminal
- 5 Manual/Automatic button
- 6 Manual/Automatic LED
- 7 Connection terminals
- 8 Channel LED
- 9 Manual operation button

Note: An external voltage connection is not permitted in the Binary Input BE/S 4.20.1.

2.3.3 Dimension drawing

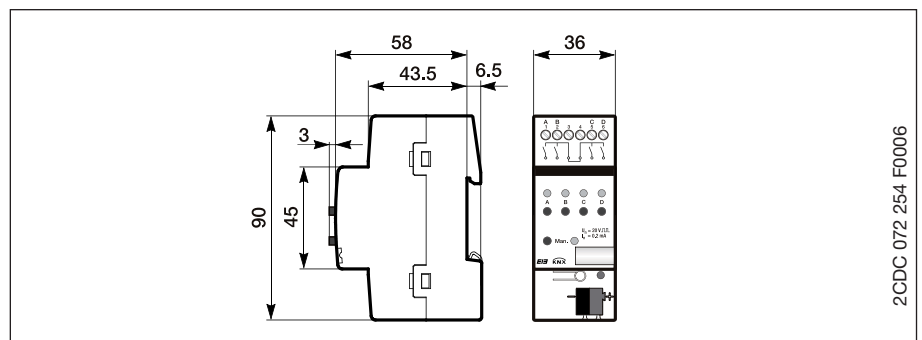

Fig. 9: Dimension Drawing BE/S 4.20.1

2.3.4 Assembly and installation

The Binary Input is a modular installation device for fast installation in the distribution board on 35 mm mounting rails to DIN EN 60 715.

The electrical connection is implemented using screw terminals. The connection to the bus is implemented using the supplied bus connection terminal.

The device is ready for operation after connection to the bus voltage. Accessibility of the devices for the purpose operation, testing, visual inspection, maintenance and repair must be provided (conform to DIN VDE 0100-520).

Commissioning requirements

To put the Binary Input BE/S 4.20.1 into operation, you require a PC with the Engineering Tool Software ETS2 from V1.3a onwards in conjunction with an RS232 interface or a USB interface. The device is ready for operation after connection to the bus voltage.

The installation and commissioning may only be carried out by electrical specialists. The appropriate norms, guidelines, regulations and specifications should be observed when planning and setting up electrical installations.

- The device should be protected from damp, dirt and damage during transport, storage and operation.
- The device should not be operated outside the specified technical data!
- The device should only be operated in a closed housing (distribution board)!

Supplied state

The Binary Input is supplied with the physical address 15.15.255. The **Binary 4f 20M/1** user program is preinstalled. Hence, only group addresses and parameters must be loaded during commissioning. The entire application can be reloaded as required. A longer downtime may result if the application program is changed or after a discharge.

Assignment of the physical address

The assignment and programming of the physical address is carried out in the ETS.

Cleaning

If devices become dirty, they can be cleaned using a dry cloth. Should a dry cloth not remove the dirt, they can be cleaned using a slightly damp cloth and soap solution. Corrosive materials or solutions should never be used.

Maintenance

The device is maintenance-free. No repairs should be carried out by unauthorised personnel if damage occurs (e.g. during transport or storage). The warranty expires if the device is opened.

2.4 Binary Input with manual operation, 8-fold, 230 V AC/DC, MDRC



2CDC 071 595 F0004

Fig. 10: BE/S 8.230.1

The 8-fold Binary Input BE/S 8.230.1 with manual operation is a rail mounted device for insertion in the distribution board. The device is suitable for reading out 0...265 V AC/DC signals. The inputs are independent of one another.

Buttons on the front of the device can be used to simulate the input state. The status of the inputs are displayed by yellow LEDs.

The device is ready for operation after connection to the bus voltage. The Binary Input is parameterised via ETS2 V1.3a or higher. The connection to the bus is established using the front side bus connection terminal.

2.4.1 Technical data

Power supply	<ul style="list-style-type: none"> - Bus voltage - Current consumption, bus - Power consumption - Leakage loss, bus Max. 	21 ... 32 V DC < 12 mA Max. 4 W 250 mW
Inputs	<ul style="list-style-type: none"> - Number - Permitted voltage range U_n - Input current I_n - Signal level for 0-signal - Signal level for 1-signal - Permitted cable lengths 	8 individual 0...265 V AC/DC Max. 2 mA 0...120 V AC/DC 180...265 V AC/DC ≤ 100 m with 1.5 mm ²
Connections	<ul style="list-style-type: none"> - EIB / KNX - Inputs 	without screws via bus connection terminal via screw terminals
Connection terminals	<ul style="list-style-type: none"> - Screw terminals - Tightening torque 	0.2 ... 2.5 mm ² finely stranded 0.2 ... 4.0 mm ² single core Max. 0.6 Nm
Operating and display elements	<ul style="list-style-type: none"> - Programming LED - Programming button - Channel LED - Manual operation button - Manuell/Automatik-LED (Man.) - Manual/Automatic button (Man.) 	for assignment of the physical address for assignment of the physical address 1 LED per channel for display of the input state 1 button per channel for changing the input state 1 LED for display of the manual/automatic mode states 1 button for switchover of manual and automatic mode
Enclosure	<ul style="list-style-type: none"> - IP 20 	to DIN EN 60 529
Safety class	<ul style="list-style-type: none"> - II 	to DIN EN 61 140
Temperature range	<ul style="list-style-type: none"> - Operation - Storage - Transport 	- 5 °C...+45 °C -25 °C...+ 55 °C -25 °C...+ 70 °C
Environment conditions	<ul style="list-style-type: none"> - max. humidity 	93%, without bedewing
Design	<ul style="list-style-type: none"> - Modular installation device (MDRC) - Dimensions - Mounting width in space units - Mounting depth 	Modular installation device, ProM 90 x 72 x 67.5 mm (H x W x D) 4, 4 modules at 18 mm 67.5 mm
Installation	<ul style="list-style-type: none"> - On 35 mm mounting rails 	to DIN EN 60 715
Mounting position	<ul style="list-style-type: none"> - as required 	
Weight	<ul style="list-style-type: none"> - 0.2 kg 	
Housing/colour	<ul style="list-style-type: none"> - Plastic housing, grey 	
Approvals	<ul style="list-style-type: none"> - EIB / KNX to EN 50 090-1, -2 	certificate
CE mark	<ul style="list-style-type: none"> - in accordance with the EMC guideline and low voltage guideline 	

Table 7: Technical data BE/S 8.230.1

Application program	Max. number of communication objects	Max. number of group addresses	Max. number of associations
Binary 8f 230M/1	83	254	254

Table 8: Application program BE/S 8.230.1

Note: The programming requires EIB Software Tool ETS2 V1.3a or higher. If ETS3 is used a “.VD3” type file must be imported. The application program is available in the ETS2 / ETS3 at ABB/Input/Binary Input 4-fold.

2.4.2 Circuit diagram

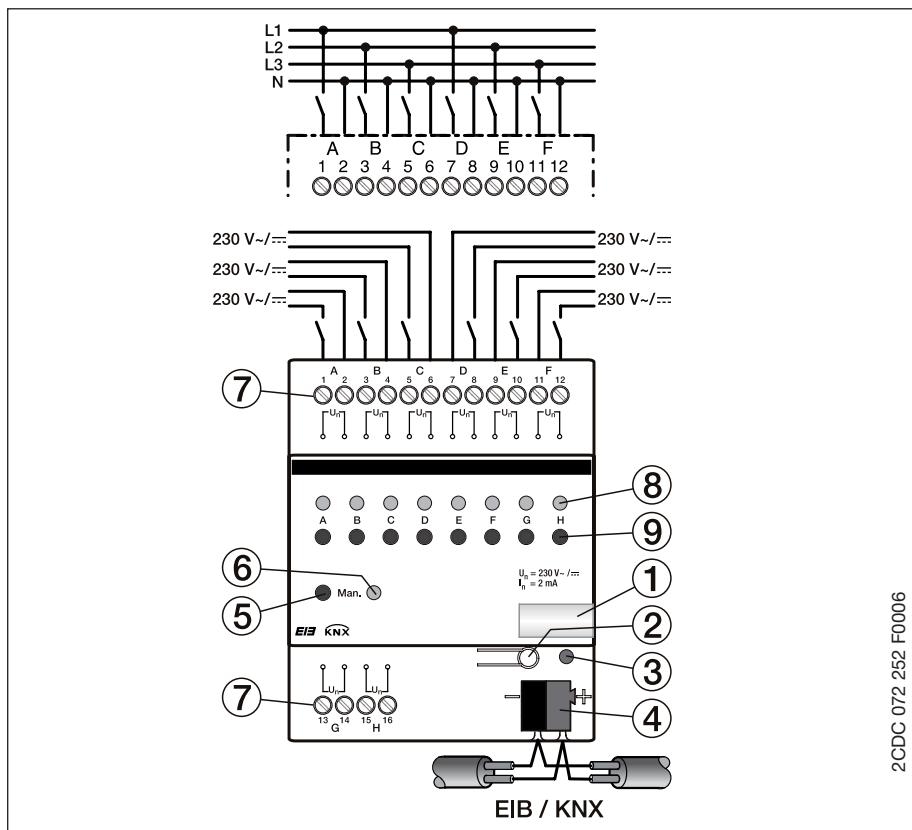

Fig. 11: Circuit diagram of BE/S 8.230.1

- 1 Label carriers
- 2 Programming button
- 3 Programming LED
- 4 Bus connection terminal
- 5 Manual/Automatic button
- 6 Manual/Automatic LED
- 7 Connection terminals
- 8 Channel LED
- 9 Manual operation button

2.4.3 Dimension drawing

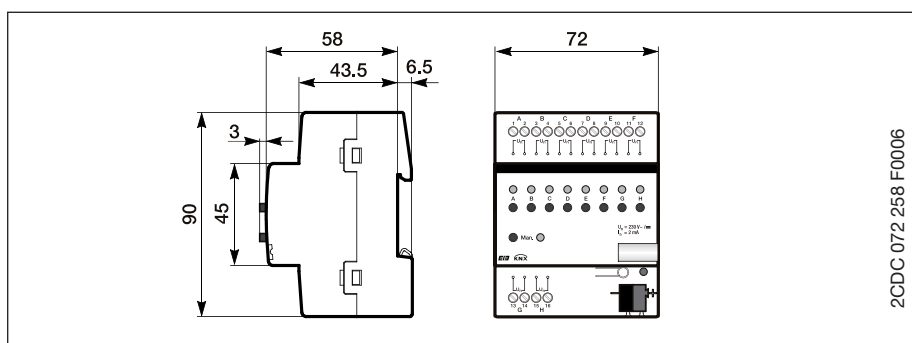

Fig. 12: Dimension drawing of BE/S 8.230.1

2.4.4 Assembly and installation

The Binary Input is a modular installation device for fast installation in the distribution board on 35 mm mounting rails to DIN EN 60 715.

The electrical connection is implemented using screw terminals. The connection to the bus is implemented using the supplied bus connection terminal.

The device is ready for operation after connection to the bus voltage. Accessibility of the devices for the purpose operation, testing, visual inspection, maintenance and repair must be provided (conform to DIN VDE 0100-520).

Commissioning requirements

To put the Binary Input BE/S 8.230.1 into operation, you require a PC with the Engineering Tool Software ETS2 from V1.3a onwards in conjunction with an RS232 interface or a USB interface. The device is ready for operation after connection to the bus voltage.

The installation and commissioning may only be carried out by electrical specialists. The appropriate norms, guidelines, regulations and specifications should be observed when planning and setting up electrical installations.

- The device should be protected from damp, dirt and damage during transport, storage and operation.
- The device should not be operated outside the specified technical data!
- The device should only be operated in a closed housing (distribution board)!

Supplied state

The Binary Input is supplied with the physical address 15.15.255. The **Binary 8f 230M/1** user program is preinstalled. Hence, only group addresses and parameters must be loaded during commissioning. The entire application can be reloaded as required. A longer downtime may result if the application program is changed or after a discharge.

Assignment of the physical address

The assignment and programming of the physical address is carried out in the ETS.

Cleaning

If devices become dirty, they can be cleaned using a dry cloth. Should a dry cloth not remove the dirt, they can be cleaned using a slightly damp cloth and soap solution. Corrosive materials or solutions should never be used.

Maintenance

The device is maintenance-free. No repairs should be carried out by unauthorised personnel if damage occurs (e.g. during transport or storage). The warranty expires if the device is opened.

2.5 Binary Input with manual operation, 8-fold, 24 V AC/DC, MDRC



2CDC071 009 F0005

Fig. 13: BE/S 8.24.1

The 8-fold Binary Input BE/S 8.24.1 with manual operation is a rail mounted device for insertion in the distribution board. The device is suitable for reading out 0...32 V AC/DC signals. The inputs are independent of one another.

Buttons on the front of the device can be used to simulate the input state. The status of the inputs are displayed by yellow LEDs.

The device is ready for operation after connection to the bus voltage. The Binary Input is parameterised via ETS2 V1.3a or higher. The connection to the bus is established using the front side bus connection terminal.

2.5.1 Technical data

Power supply	<ul style="list-style-type: none"> - Bus voltage - Current consumption, bus - Power consumption - Leakage loss, bus 	21 ... 32 V DC < 12 mA Max. 1.1 W Max. 250 W
Inputs	<ul style="list-style-type: none"> - Number - Permitted voltage range U_n - Input current I_n - Signal level for 0-signal - Signal level for 1-signal - Permitted cable lengths 	8 individual 0...32 V AC/DC Max. 5 mA 0...4 V AC/DC 9...32 V AC/DC ≤ 100 m with 1.5 mm ²
Connections	<ul style="list-style-type: none"> - EIB / KNX - Inputs 	via bus connection terminal, without screws using screw terminals
Connection terminals	<ul style="list-style-type: none"> - Screw terminals - Tightening torque 	0.2 ... 2.5 mm ² finely stranded 0.2 ... 4.0 mm ² single-core max. 0.6 Nm
Operating and display elements	<ul style="list-style-type: none"> - Programming LED (3) - Programming button (2) - Channel LED (8) - Manual operation button (9) - Manual/Automatic LED (Man.) (6) - Manual/Automatic button (Man.) (5) 	for assignment of the physical address for assignment of the physical address 1 LED per channel for display of the input state 1 button per channel for changing the input state 1 LED for display of the manual/automatic mode states 1 button for switchover of manual and automatic mode
Enclosure	<ul style="list-style-type: none"> - IP 20 	to DIN EN 60 529
Safety class	<ul style="list-style-type: none"> - II 	to DIN EN 61 140
Temperature range	<ul style="list-style-type: none"> - Operation - Storage - Transport 	- 5 °C...+ 45 °C - 25 °C...+ 55 °C - 25 °C...+ 70 °C
Environment conditions	<ul style="list-style-type: none"> - max. humidity 	93%, without bedewing
Design	<ul style="list-style-type: none"> - Modular installation device (MDRC) - Dimensions - Mounting width in space units - Mounting depth 	Modular installation device, ProM 90 x 72 x 67.5 mm (H x W x D) 4, 4 modules at 18 mm 67.5 mm
Installation	<ul style="list-style-type: none"> - On 35 mm mounting rail 	to DIN EN 60 715
Mounting position	<ul style="list-style-type: none"> - as required 	
Weight	<ul style="list-style-type: none"> - 0.2 kg 	
Housing/colour	<ul style="list-style-type: none"> - Plastic housing, grey 	
Approvals	<ul style="list-style-type: none"> - EIB / KNX to EN 50 090-1, -2 	Certification
CE mark	<ul style="list-style-type: none"> - in accordance with the EMC guideline and low voltage guideline 	

Table 9: Technical data BE/S 8.24.1

Application program	Max. number of communication objects	Max. number of group addresses	Max. number of associations
Binary 8f 24M/1	83	254	254

Table 10: Application program BE/S 8.24.1

Note: The programming requires EIB Software Tool ETS2 V1.3a or higher. If ETS3 is used a ".VD3" type file must be imported. The application program is available in the ETS2 / ETS3 at ABB/Input/Binary Input 4-fold.

2.5.2 Circuit diagram

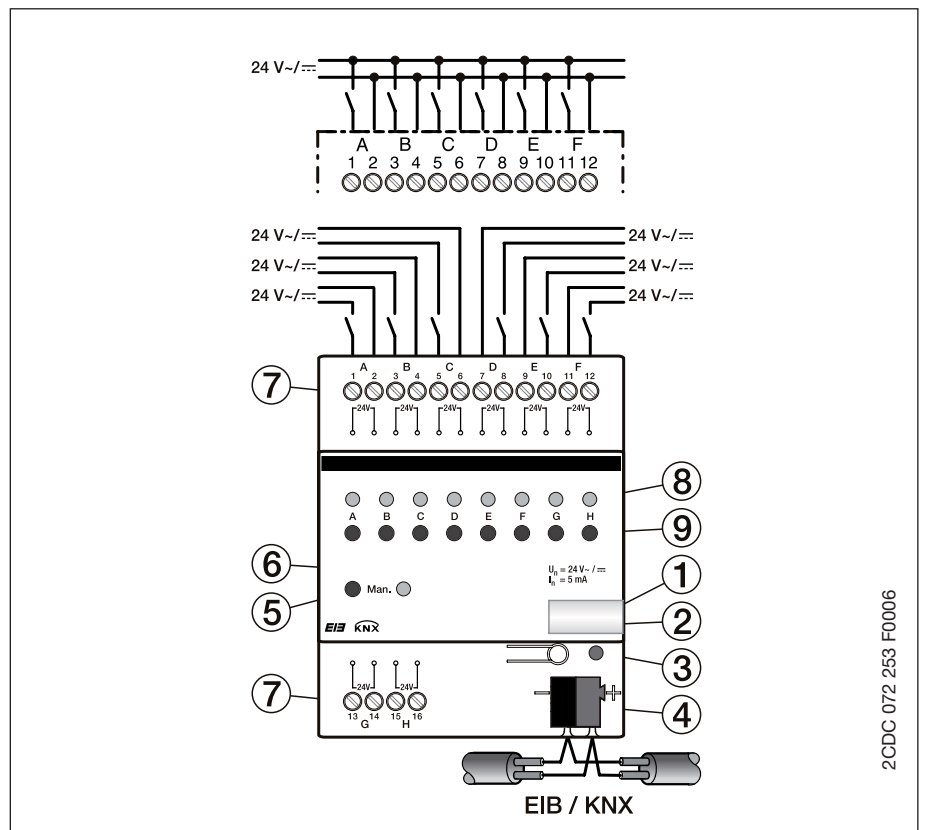

Fig. 14: Circuit diagram of BE/S 8.24.1

- 1 Label carriers
- 2 Programming button
- 3 Programming LED
- 4 Bus connection terminal
- 5 Manual/Automatic button
- 6 Manual/Automatic LED
- 7 Connection terminals
- 8 Channel LED
- 9 Manual operation button

2.5.3 Dimension drawing

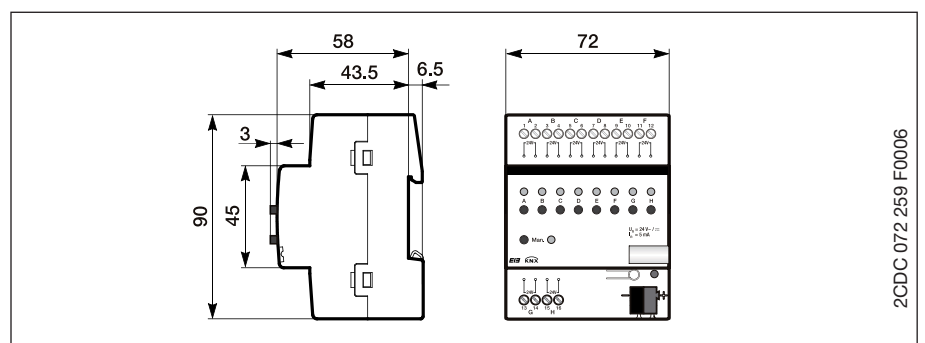

Fig. 15: Dimension drawing of BE/S 8.24.1

2CDC 072 253 F0006

2CDC 072 259 F0006

2.5.4 Assembly and installation

The Binary Input is a modular installation device for fast installation in the distribution board on 35 mm mounting rails to DIN EN 60 715.

The electrical connection is implemented using screw terminals. The connection to the bus is implemented using the supplied bus connection terminal.

The device is ready for operation after connection to the bus voltage. Accessibility of the devices for the purpose operation, testing, visual inspection, maintenance and repair must be provided (conform to DIN VDE 0100-520).

Commissioning requirements

To put the Binary Input BE/S 8.24.1 into operation, you require a PC with the Engineering Tool Software ETS2 from V1.3a onwards in conjunction with an RS232 interface or a USB interface. The device is ready for operation after connection to the bus voltage.

The installation and commissioning may only be carried out by electrical specialists. The appropriate norms, guidelines, regulations and specifications should be observed when planning and setting up electrical installations.

- The device should be protected from damp, dirt and damage during transport, storage and operation.
- The device should not be operated outside the specified technical data!
- The device should only be operated in a closed housing (distribution board)!

Supplied state

The Binary Input is supplied with the physical address 15.15.255. The **Binary 8f 24M/1** user program is preinstalled. Hence, only group addresses and parameters must be loaded during commissioning. The entire application can be reloaded as required. A longer downtime may result if the application program is changed or after a discharge.

Assignment of the physical address

The assignment and programming of the physical address is carried out in the ETS.

Cleaning

If devices become dirty, they can be cleaned using a dry cloth. Should a dry cloth not remove the dirt, they can be cleaned using a slightly damp cloth and soap solution. Corrosive materials or solutions should never be used.

Maintenance

The device is maintenance-free. No repairs should be carried out by unauthorised personnel if damage occurs (e.g. during transport or storage). The warranty expires if the device is opened.

2.6 Binary Input with manual operation, 8-fold, contact scanning, MDRC



2CDC 071 008 F0005

Fig. 16: BE/S 8.20.1

The 8-fold Binary Input BE/S 8.20.1 with manual operation is a rail mounted device for insertion in the distribution board. The device is suitable for reading out of floating contacts. The pulsed polling voltage is generated internally.

Buttons on the front of the device can be used to simulate the input state. The status of the inputs are displayed by yellow LEDs.

The device is ready for operation after connection to the bus voltage. The Binary Input is parameterised via ETS2 V1.3a or higher. The connection to the bus is established using the front side bus connection terminal.

2.6.1 Technical data

Power supply	– Bus voltage – Current consumption, – Leakage loss, bus	21 ... 32 V DC < 12 mA Max. 250 mW
Inputs	– Number – Polling voltage U_n – Sensing current I_n – Sensing current I_n when switching on – Permitted cable lengths	8 32 V, pulsed 0.1 mA Max. 355 mA ≤ 100 m with 1.5 mm ²
Connections	– EIB / KNX – Inputs	via bus connection terminal, without screws via screw terminals
Connection terminals	– Screw terminals – Tightening torque	0.2 ... 2.5 mm ² finely stranded 0.2 ... 4.0 mm ² single core Max. 0.6 Nm
Operating and display elements	– Programming LED – Programming button – Channel LED – Manual operation button – Manual/Automatic LED (Man.) – Manual/Automatic button (Man.)	for assignment of the physical address for assignment of the physical address 1 LED per channel for display of the input state 1 button per channel for changing the input state 1 LED for display of the manual/automatic mode states 1 button for switchover of manual and automatic mode
Enclosure	– IP 20	to DIN EN 60 529
Safety class	– II	to DIN EN 61 140
Temperature range	– Operation – Storage – Transport	– 5 °C...+ 45 °C – 25 °C...+ 55 °C – 25 °C...+ 70 °C
Environment conditions	– max. humidity	93%, without bedewing
Design	– Modular installation device (MDRC) – Dimensions – Mounting width in space units – Mounting depth	Modular installation device, ProM 90 x 72 x 67.5 mm (H x W x D) 4, 4 modules at 18 mm 67.5 mm
Installation	– On 35 mm mounting rails	to DIN EN 60 715
Mounting position	– as required	
Weight	– 0.2 kg	
Housing/colour	– Plastic housing, grey	
Approvals	– EIB / KNX to EN 50 090-1, -2	certificate
CE mark	– in accordance with the EMC guideline and low voltage guideline	

Table 11: Technical data BE/S 8.20.1

Application program	Max. number of communication objects	Max. number of group addresses	Max. number of associations
Binary 8f 20M/1	83	254	254

Table 12: Application program BE/S 8.20.1

Note: The programming requires EIB Software Tool ETS2 V1.3a or higher. If ETS3 is used a “.VD3” type file must be imported. The application program is available in the ETS2 / ETS3 at ABB/Input/Binary Input 4-fold.

2.6.2 Circuit diagram

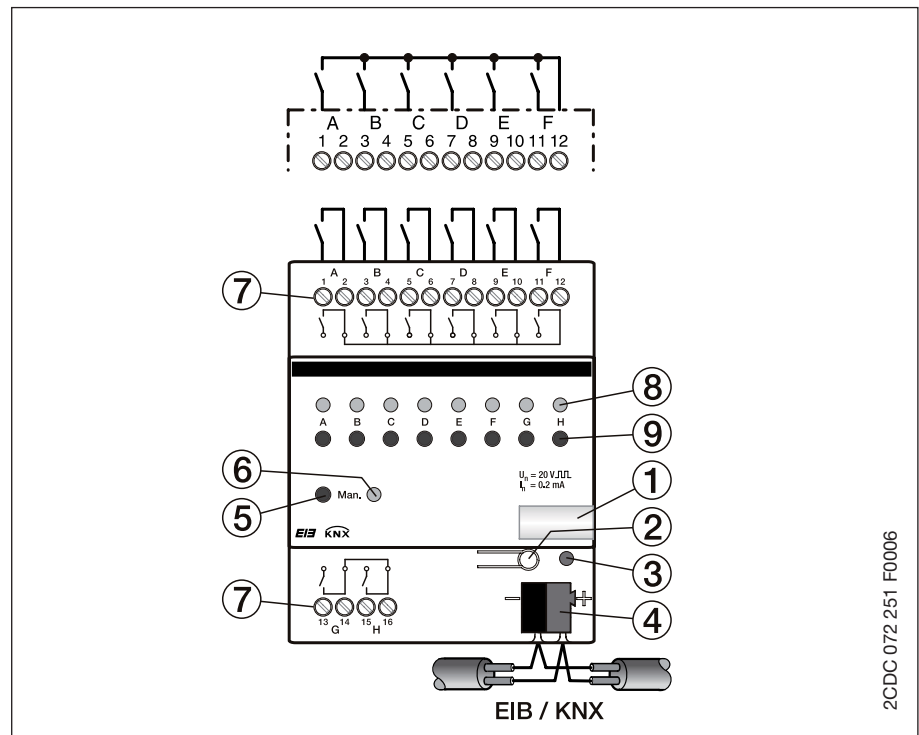

Fig. 17: Circuit diagram of BE/S 8.20.1

- 1 Label carriers
- 2 Programming button
- 3 Programming LED
- 4 Bus connection terminal
- 5 Manual/Automatic button
- 6 Manual/Automatic LED
- 7 Connection terminals
- 8 Channel LED
- 9 Manual operation button

Note: An external voltage connection is not permitted in the Binary Input BE/S 8.20.1.

2.6.3 Dimension drawing

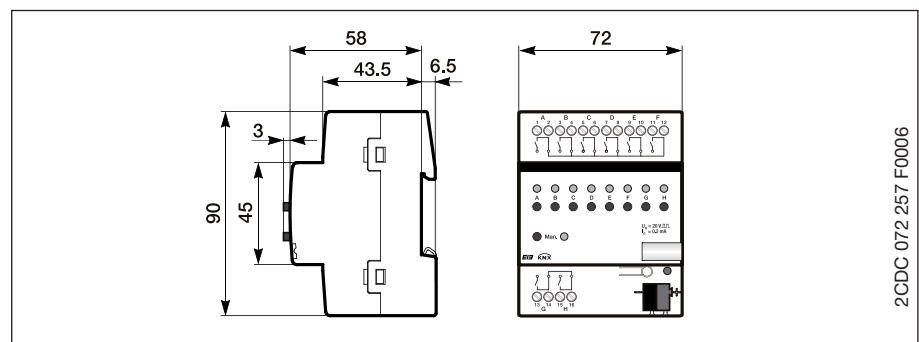

Fig. 18: Dimension drawing of BE/S 8.20.1

2.6.4 Assembly and installation

The Binary Input is a modular installation device for fast installation in the distribution board on 35 mm mounting rails to DIN EN 60 715.

The electrical connection is implemented using screw terminals. The connection to the bus is implemented using the supplied bus connection terminal.

The device is ready for operation after connection to the bus voltage. Accessibility of the devices for the purpose operation, testing, visual inspection, maintenance and repair must be provided (conform to DIN VDE 0100-520).

Commissioning requirements

To put the Binary Input BE/S 8.20.1 into operation, you require a PC with the Engineering Tool Software ETS2 from V1.3a onwards in conjunction with an RS232 interface or a USB interface. The device is ready for operation after connection to the bus voltage.

The installation and commissioning may only be carried out by electrical specialists. The appropriate norms, guidelines, regulations and specifications should be observed when planning and setting up electrical installations.

- The device should be protected from damp, dirt and damage during transport, storage and operation.
- The device should not be operated outside the specified technical data!
- The device should only be operated in a closed housing (distribution board)!

Supplied state

The Binary Input is supplied with the physical address 15.15.255. The **Binary 8f 20M/1** user program is preinstalled. Hence, only group addresses and parameters must be loaded during commissioning. The entire application can be reloaded as required. A longer downtime may result if the application program is changed or after a discharge.

Assignment of the physical address

The assignment and programming of the physical address is carried out in the ETS.

Cleaning

If devices become dirty, they can be cleaned using a dry cloth. Should a dry cloth not remove the dirt, the devices can be cleaned using a slightly damp cloth and soap solution. Corrosive materials or solutions should never be used.

Maintenance

The device is maintenance-free. No repairs should be carried out by unauthorised personnel if damage occurs (e.g. during transport or storage). The warranty expires if the device is opened.

3 Commissioning

3.1 Overview

The user programs “*Binary 4f 230M/1, Binary 4f 24M/1, Binary 4f 20M/1, Binary 8f 230M/1, Binary 8f 24M/1 and Binary 8f 20M/1*” are available for the Binary Inputs. Programming requires ETS2 V1.3a or higher. If ETS3 is used a “.VD3” type file must be imported. A maximum of 10 communication objects per channel, 254 group addresses and 254 associations can be linked.

The following operating modes are available for each channel:

Switch sensor / fault signal input	For switching the lighting or scanning conventional contacts. Distinction between long and short operation and cyclical sending of the contact state are possible. Blocking a channel is possible. The operating mode can be used as a fault signal input.
Switch/dimming sensor	For switching/dimming the lighting via a one push button or two push button function. Start-stop dimming and stepwise dimming as well as dimming via a single push button are possible.
Shutter sensor	For movement/lamella adjustment of a blind or a shutter via a one push button or two push button function. Eight preset operating responses are possible in total.
Value / forced operation	For sending values of different data types (e.g. temperature values). It is possible to send different values or data types after a short/long operation. The activation/deactivation of the priority control of actuators is also possible.
Control scene	For recalling and storing the states of several actuator groups. The actuator groups can be controlled via max. 6 individual objects.
Switching sequence	For the operation of several actuator groups in preset sequences.
Push button with multiple operation	For triggering various functions depending on the frequency of operation. A long operation can also be detected and trigger a function.
Counter	For counting input pulses. Different data types can be set for the counter. An additional differential counter enables the counting of daily values for example. Different count rates can be set.

Table 13: Functions of the application program

Note: Every channel of a device can be blocked separately by a communication object.

3.1.1 Conversion of earlier user programs

With the aid of the conversion it is possible from ETS3 to accept the parameters and group addresses from previous application programs.

Procedure:

1. Import the current VD3 file into the ETS3 and append a product with the current application program into the project.
2. Click with the right mouse button on the product and select "Convert".

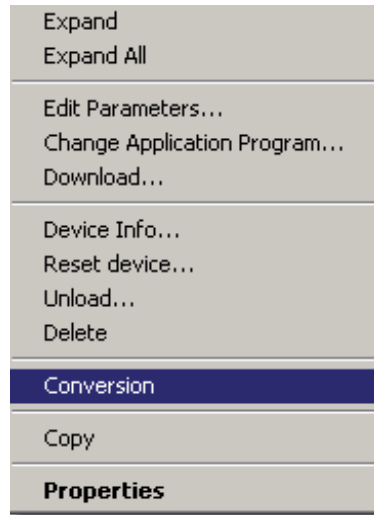

Fig. 19: Conversion of previous application programs

3. Then follow the instructions

The following application programs can be converted:

Name of the application program	Note
Binary 4f 230M/1.0, Binary 4f 24M/1.0, Binary 4f 20M/1.0, Binary 8f 230M/1.0 Binary 8f 24M/1.0 and Binary 8f 20M/1.0	Complete conversion is possible.

Table 14: Functions of the application program

Note: Please note that the standard values can be set after conversion of newly added parameters.

4. Then change the existing physical address and delete the old device.

3.2 Parameters

3.2.1 General parameters

3.2.1.1 Parameter window "General"

Note: The standard settings for the options are underlined, e.g. Option: yes/no.

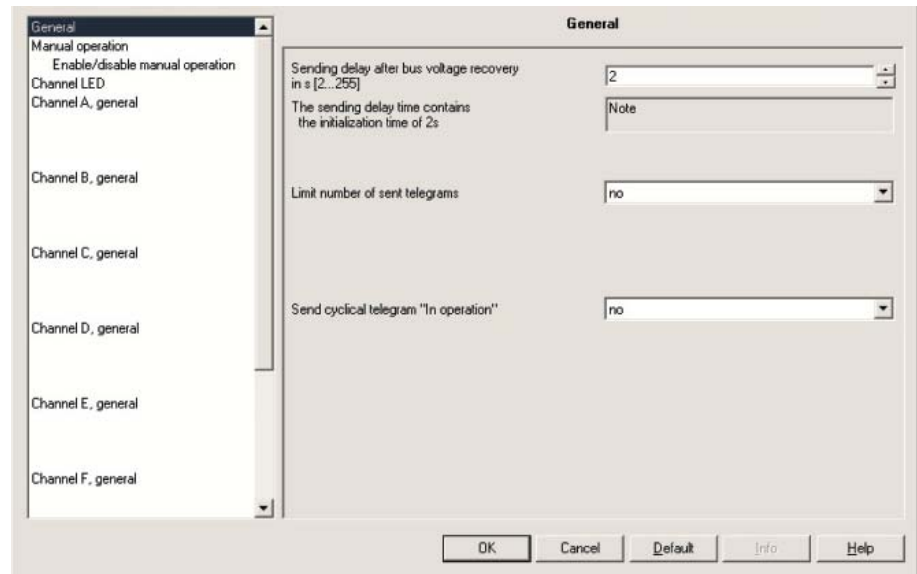

Fig. 20: Parameter window "General"

Send delay [2...255s] after bus voltage recovery

Options: 2...255

The sending delay time determines the time between the bus voltage recovery and the point from which telegrams can be sent. An initialisation time of about 2 seconds for the start of the device is included in the delay time for sending.

If communication objects are read out via the bus during the sending delay time (e.g. from the visualisations), these requests are stored and sent after the sending time delay has timed out.

The following communication objects send a telegram after start up of the device when the send delay time has timed out.

- Communication object "In operation – System" sends a 1 bit telegram

A 2 s delay time for sending is included in the initialisation time

This parameter serves as a note or remark.

How does the device behave during bus voltage recovery?

After recovery of the bus voltage the system waits until the delay time for sending has timed out before telegrams are sent on the bus.

The following drawing indicates the sequence involved:

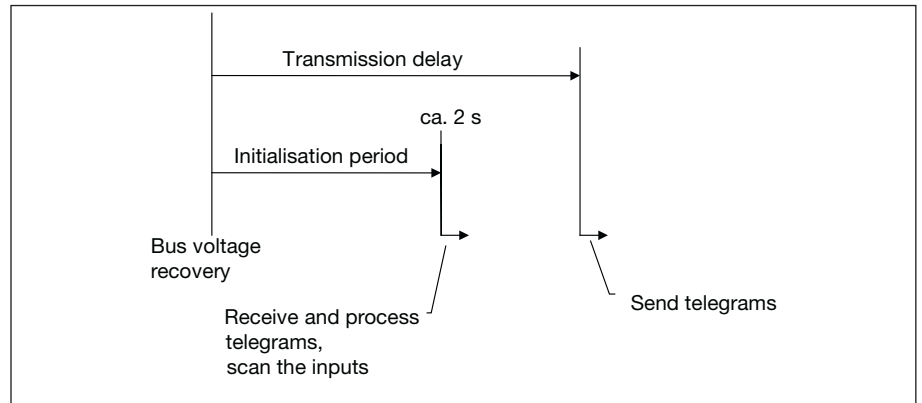

Fig. 21: Behaviour after voltage recovery

The inputs are scanned and the object values are updated accordingly – if possible – as soon as the bus voltage recovers after the initialisation time (approx. 2s). If an input has been actuated, the device will react as if the actuation has commenced at the end of the initialisation time.

The behaviour is dependent on the operating modes of the channel. The following list provides an overview:

Operating modes	Behaviour after voltage recovery (behaviour after the send delay time has timed out)
Switch sensor / fault signal input	If a distinction is made between short and long operation, or if the “TOGGLE” value is set in one of the “Reaction on closing/opening the contact” parameters, no telegram will be sent on bus voltage recovery. Otherwise the behaviour can be set in the parameters.
Switch/dimming sensor	No telegram is sent on the bus.
Shutter sensor	No telegram is sent on the bus.
Switching sequence	No telegram is sent on the bus.
Push button with multiple operation	No telegram is sent on the bus.
Counter	No telegram is sent on the bus.

Table 15: Behaviour after voltage recovery

How does the device behave after programming?

After programming the device behaves as after bus voltage recovery.

In addition the scene values are set with the following characteristics to the initialized values:

- With first programming
- with a change to the operation mode of “Control scene” and
- by the communication object 19
“Channel X scene control – Restore scene to default”

Limit the number of telegramsOptions: yes/no

A telegram limitation is implemented to control the bus load created by the device.

When yes is selected in the *Limit the number of telegrams* parameter the *Max. number of sent ... and Duration of the...* parameters appear.

Max. number of sent telegrams within the observation periodOptions: 0...20...255

This parameter sets the number of telegrams which can be sent within an observation period.

Duration of the observation periodOptions: 50 ms/100 ms/200 ms/500 ms/1 s/2 s/5 s/10 s/30 s/1 min

The *duration of the observation period* is set with this parameter.

What is a limitation of the telegram rate and an observation period?

A new observation period starts after the end of the previous observation period or – in the event of a bus voltage recovery – after the end of the send delay time. The sent telegrams are counted. As soon as the *Max. number of transmitted telegrams...* has been reached, no further telegrams are sent on the bus until the end of the observation period.

With the start of a new observation period, the telegram counter is reset to zero and the sending of telegrams is permitted again.

Send cyclic “In operation” telegramOptions: yes/no

Option *no* = *Cyclic “In operation” telegram* is not sent

Option *yes* = the “In operation – System” communication object appears

With *yes* selected in the *Send cyclic “In operation” telegram*, the parameters *Basic* and *Factor* appear.

BasicOptions: 1 s/10 s/1 min/10 min/1 h**Factor [1...255]**Options: 1...60...255

3.2.1.2 Parameter window “Manual Operation”

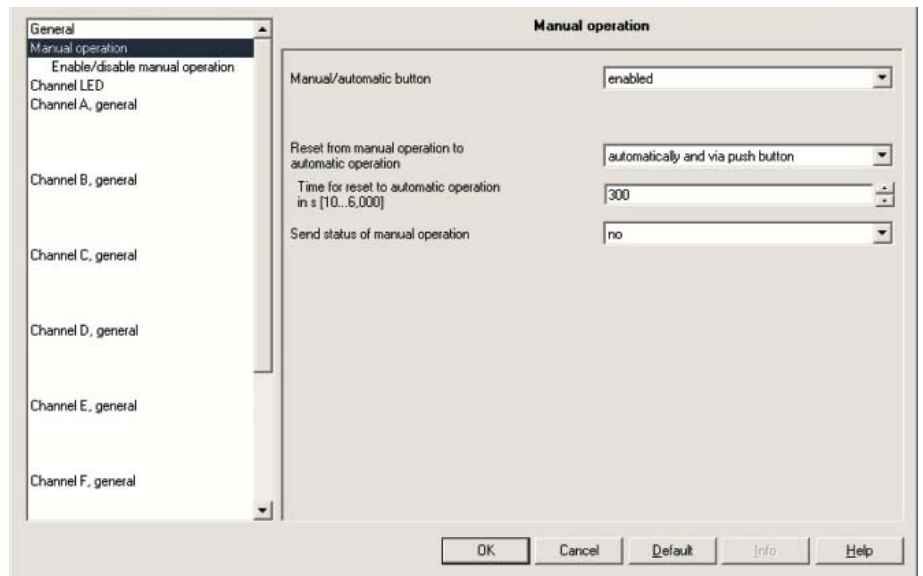

Fig. 22: Parameter window “Manual Operation”

How does the manual operation function?

The devices are in “Automatic mode” after connection to the BUS. The Manual/Automatic LED (Man.) is off. Changeover to “manual operation” is possible. The respective “channel LED’s” indicate the current input status. The respective “Manual operation buttons” do not have a function.

It is possible to switch between “manual operation“ and “automatic operation” by pressing the Manual/Automatic button (Man.). With a long button push (> 1 second) the device changes over to “manual operation”. With a short button push (< 1 second) the device changes over to “automatic operation”. In the “manual mode” the Manual/Automatic LED (Man.) is yellow. In the “automatic mode” the Manual/Automatic LED (Man.) is off.

“Manual mode” can be blocked using the application program. If the “manual mode” is blocked, the Manual/Automatic LED (Man.) will flash for 3 seconds before manual mode goes off and the device remains in “automatic mode”.

Manual / automatic button

Options: enable/block via communications object/enable

The parameter defines if the switchover between the “manual operation” and “automatic operation” operating states is blocked or enabled using the Manual/Automatic button (Man.) on the Binary Input.

If the *enable/block via communications object* is selected, the “block manual operation key” communications object appears.

Telegram value “0” enable manual operation button
 “1” block manual operation button

Note: The manual operation can automatically overwrite the input states.

How is switchover made between “automatic operation” and “manual operation”?

When switching over from “automatic operation” to the “manual operation”, the Manual/Automatic LED (Man.) will flash for 3 seconds in “manual operation” after the Manual/Automatic button (Man.) is pressed. If “manual operation” is enabled via the application program, switchover to “manual operation” occurs and the Manual/Automatic LED (Man.) is on. The respective “channel LED’s” indicate the current input status.

The states of the individual channels can be changed by the “manual operation buttons”. Telegrams will be sent to the Bus if group addresses are assigned! Any signal changes from the installation system are not taken into consideration. With switchover to the “automatic operation” the respective “channel LED’s” will once again indicate their current states. The communication objects are updated and telegrams will be sent if necessary.

Reset from manual operation to automation operation

Options: via button/automatic and via button

This parameter defines how long the Binary Input remains in the “manual operation” state after the “Manual/Automatic button (Man.)” has been pressed.

If the *automatic and via button* option is selected, the Binary Input will remain in “manual operation” until the Manual/Automatic button (Man.) is pressed again or the parameterised *Time for automatic reset [10...6.000s]* has timed out.

If the *via button* option is selected, the Binary Input will remain in “manual operation” until the Manual/Automatic button (Man.) is pressed again.

How is switchover made between “manual operation” and “automatic operation”?

The Manual/Automatic button (Man.) is pressed for 1 s when switching over from “manual operation” to the “automatic operation”. The Manual/Automatic LED (Man.) flashes for 3 seconds and switchover of the operating state occurs. Depending on the parameterisation, the operating state can switch back automatically to “automatic operation” after a predefined time has timed out. The device is in “automatic operation” if the Manual/Automatic LED (Man.) is off.

Thereafter, the current input states are scanned, displayed and sent if necessary. The operating state will also change automatically to “automatic operation” if the “manual/automatic operation” is blocked via a telegram. The Manual/Automatic LED (Man.) will also flash for 3 seconds with an automatic change of the operating state. In the “automatic operation” state the manual operation button is not operational for every channel. In the “manual operation” state the input states can be simulated via the manual operation buttons. Changes of incoming input states from the installation system are not passed on. With switchover, the current input states are automatically scanned, displayed and sent if necessary.

If the option *automatic and via button* in the *reset from “manual operation” to “automatic operation”* parameter is selected, the following parameter will appear.

Time for automatic reset [10...6.000 s]

Options: 10...300...6000

For setting the time for automatic reset from the “manual operation” to “automatic operation” state after the last push of a button.

Send manual operation status

Options: yes/no

If the “yes” option is selected, the “Man. operating status” communications object appears.

Telegram value	“0” Automatic operation
	“1” Manual operation

If the yes option is selected in the *Send manual operation status* parameter, the following note will appear.

Status is always sent after change.

3.2.1.3 Parameter window “Enable/release manual operation button”

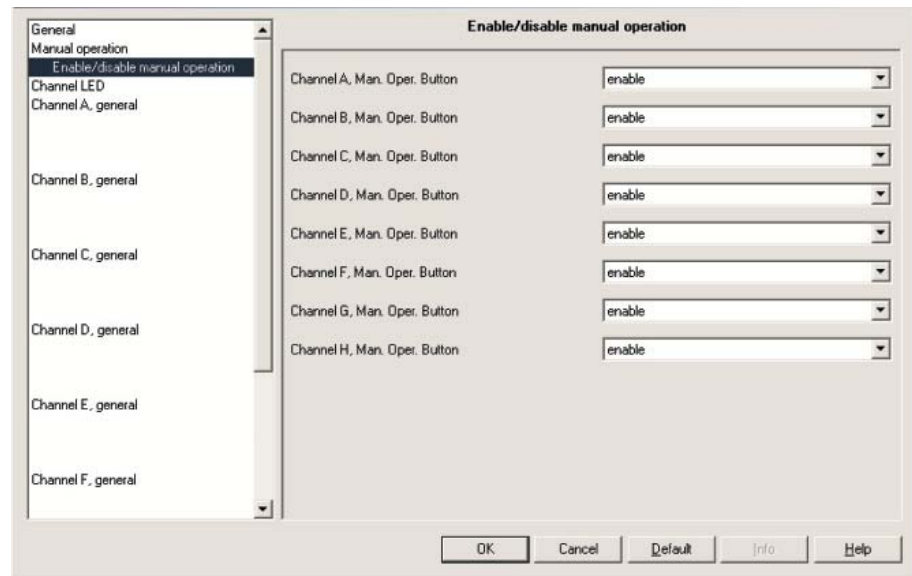

Fig. 23: Parameter window “Enable/release manual operation”

Channel A...X manual operation button

Options: block/enable

This parameter enables or blocks the operation of the manual operation button. It is set separately for each channel.

Option *block* = manual operation button is blocked

Option *enable* = manual operation button is enabled

This inhibits onsite operation to prevent malfunctions.

For safety-relevant systems such as for fault signals the button functions are inhibited using the *block* option.

How is it indicated that a channel is blocked or enabled?

The blocking function is set in the application program.

On blocked channels the respective channel LED will not react if the respective manual operation button is pressed!

How does the manual operation button function?

The first time the manual operation button is actuated, closing of the “external contact” is simulated. Nothing happens when the button is released.

The second time the manual operation button is actuated, opening of the “external contact” is simulated. Nothing happens when the button is released.

3.2.1.4 Parameter window
“Channel LED display”

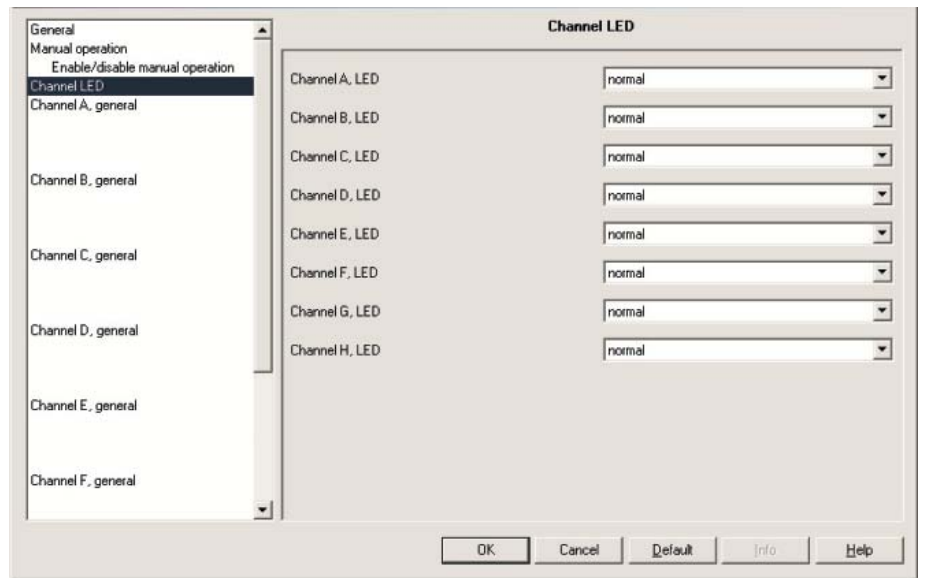

Fig. 24: Parameter window “Channel LED display”

Channel A...X LED display

Options: normal/inverting

This parameter is used to represent the LED display as a normal or inverted function. It is set separately for each channel.

Option *normal*

Contact is closed	=> signal is present	=> LED on
Contact is open	=> no signal	=> LED off

Option *inverted*

Contact is closed	=> signal is present	=> LED off
Contact is open	=> no signal	=> LED on

It is thus possible to match LED display to the input status for closed and opened contacts.

For example, normally closed (NC, break) and normally opened (NO, make) contacts can be used for fault signals.

3.2.1.5 Communication objects
“General”

Number	Object Function	Name	Length	C	R	W	T	U
0	Blocking man. operation button	Channel A...D	1 bit	C	-	W	-	-
1	Status of manual operation	Channel A...D	1 bit	C	R	-	T	-
2	Disable	System	1 bit	C	R	-	T	-

Fig. 25: Communication objects “General”

No.	Function	Object name	Data type	Flags
0	Block manual/automatic button	Channel A...X	EIS 1, 1 bit DTP 1.002	C, W
Telegram value “0” Release Manual/Automatic button “1” Block Manual Automatic button The “manual operation” of the Binary Inputs is blocked or enabled via this communication object. If the value “0” is contained in this communication object, the Binary Input will be converted to “manual operation” via the manual operation button (Man.) on the device. During this setting the channel states on the input terminals will not be passed on. If the value “1” is contained in this communication object, the Binary Input will be operated exclusively via the bus.				
1	Status of manual operation	Channel A...X	EIS 1, 1 bit DTP 1.003	C, R, T
Telegram value “0” automatic operation “1” manual operation On this communication object the Binary Input sends information regarding whether the “manual operation” or the “automatic operation” is active. The status is sent after a change.				
2	In operation	System	EIS1, 1 bit DTP 1.003	C, R, T
Telegram value “0” system not in operation “1” system in operation This communication object is only active if “yes” has been selected for the parameter <i>cyclic “In operation” telegram</i> . As long as the communication object is activated, it will cyclically send (adjustable via Basic and Factor) an “In operation” telegram.				
3	not assigned			
...				
9				

Table 16: Communication objects 0 to 9 “General”

3.2.1.6 Parameter window “Channel A, general”

The parameters for “Channel A” are described in the following. The explanations also apply for “Channels B...X”.

Note: The standard settings for the options are underlined, e.g. option: yes/no.

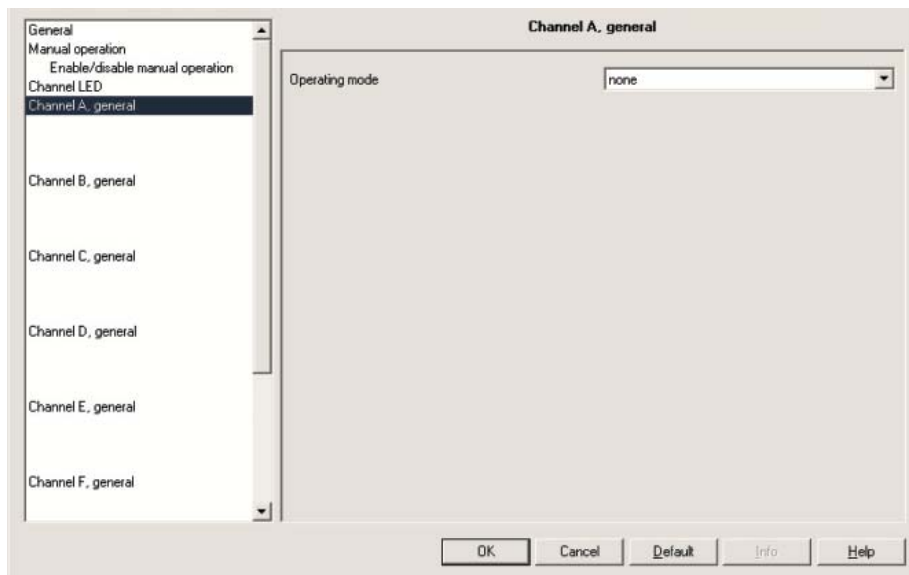

Fig. 26: Parameter window “Channel A, general”

Operating mode

Options: none

- Switch sensor / fault signal input
- Switch/dimming sensor Shutter sensor
- Value / forced operation
- Control scene
- Switching sequence
- Push button with multiple operation
- Counter

The channel operating mode is set with this parameter.

3.2.2 Operating mode switch sensor/ fault signal input

The “switch sensor operating mode” is described in the following.

Note: The standard settings for the options are underlined, e.g. option: yes/no.

3.2.2.1 Parameter window “Channel A, general”

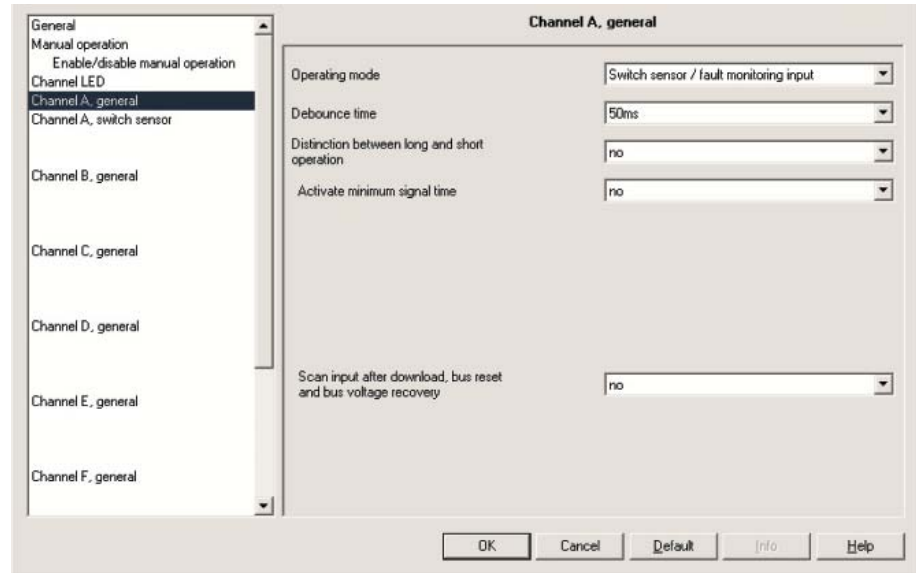

Fig. 27: Parameter window “Channel A, general” switch sensor operating mode

Debounce time

Options: 10 ms/20 ms/30 ms/50 ms/70 ms/100 ms/150 ms

Debouncing prevents unwanted multiple operation of the input, e.g. due to bouncing of the contact.

What is debounce time?

If a pulse edge is detected at the input, the input reacts to it immediately (e.g. by sending a telegram). The debounce time T_D starts simultaneously. The signal at the input is not evaluated within the debounce period.

The following example illustrates this:

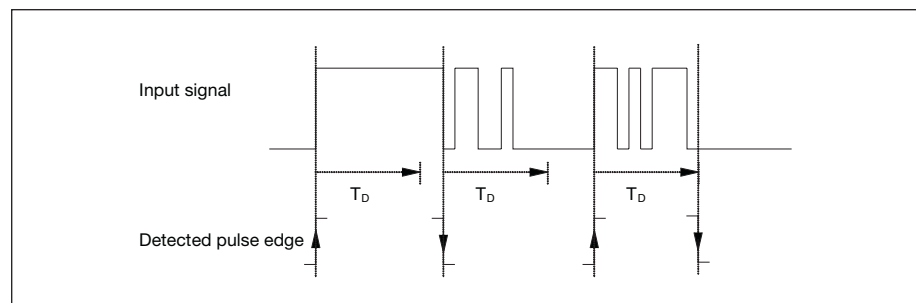

Fig. 28: Debounce time from input signal to detected edge

Once a pulse edge has been detected at the input, further edges are ignored for the duration of the debounce time T_D .

Distinction between long and short operationOptions: yes/no

This parameter defines whether the input distinguishes between a short and long operation.

If “yes” is selected, there is a delay after opening/closing the contact to determine whether there is a short or long operation. Only then is a possible reaction triggered.

The following diagram illustrates the function:

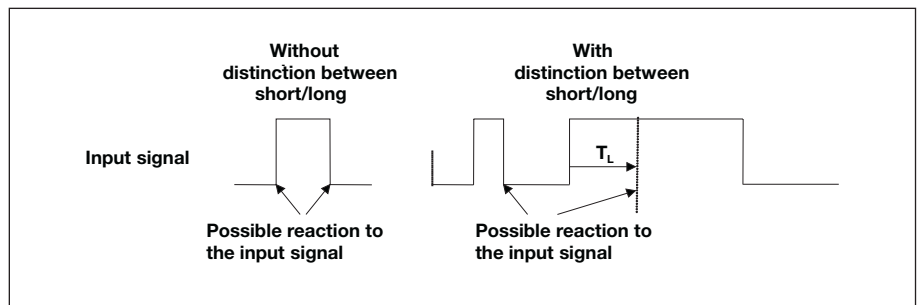

T_L is the period after which a push button action is recognised as a long operation.

Fig. 29: Distinction between short/long operation for “Switch sensor” function

The following parameters are visible in the parameter window “Channel A, general” if the option *no* has been selected with the parameter *Distinction between long and short operation*.

Activate minimum signal timeOptions: yes/no**What is minimum signal time?**

This function differs from the debounce time by the fact that the telegram is sent only after the minimum signal time has timed out.

The functions in detail:

If an edge is detected at the input, the minimum signal time commences. No telegram is sent on the bus during this time. The signal at the input is monitored within the minimum signal time. If a further edge is detected at the input during the minimum signal time, this is interpreted as a renewed actuation and the minimum signal time restarts if necessary. If the input signal has not changed during the minimum signal time, an edge is detected and a telegram is sent on the bus if necessary.

The following example illustrates this:

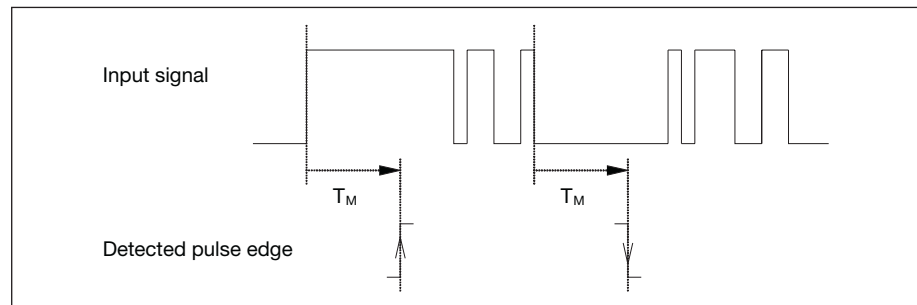

Fig. 30: Minimum signal time from input signal to detected edge

Since only two pulse edges remain stable for the duration of the minimum signal time T_M , only these pulse edges are recognised as valid.

Scan input after download, bus reset and bus voltage recovery

Options: yes/no

Option *yes* = object value is scanned after download, bus reset and bus voltage recovery.

Option *no* = object value is not scanned after download, bus reset and bus voltage recovery.

If the option *yes* is selected in the parameter *Scan input after download, bus reset and bus voltage recovery after download*, the following parameters become visible.

Inactive wait state after bus voltage recovery [0...30.000s, 0=inactive]

Options: 0...30.000

This parameter is used to set the waiting time after bus voltage recovery. The state at the input terminals is detected after this time has timed out. The input reacts as if the state at the input terminals has just been set/not set.

Note: The inactive wait state does not add to the adjustable delay time for sending. It can be set in the “General” parameter window.

If the option *yes* is selected with the parameter *Activate minimum signal time*, the following parameters are visible.

After rising edge: time base

Options: 100ms/1s/10s/1 min/10min/1 h

Factor [1...255]

Options: 1...10...255

After falling edge: time base

Options: 100ms/1s/10s/1 min/10min/1 h

Factor [1...255]

Options: 1...10...25

The following parameters are visible in the parameter window “Channel A, general” if the option *yes* has been selected with the parameter *Distinction between long and short operation*.

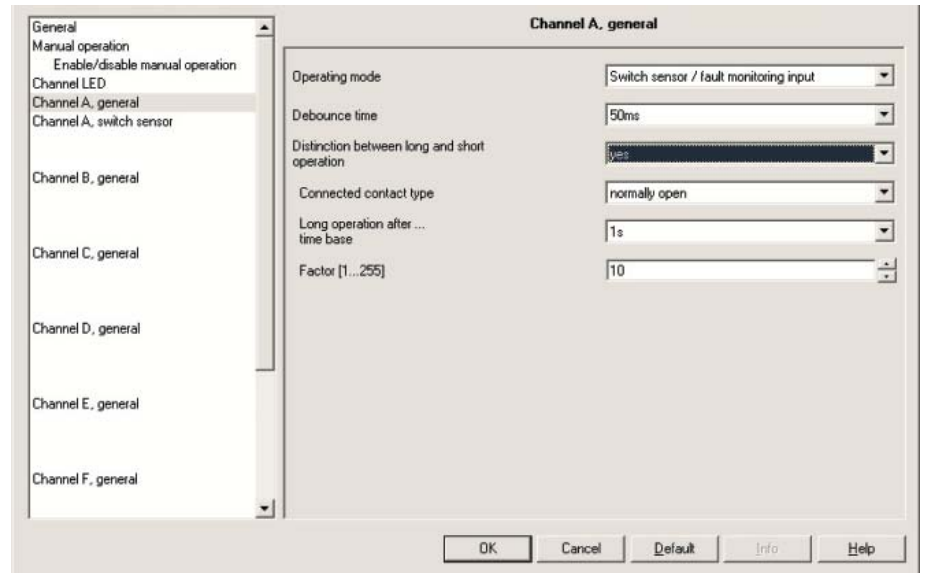

Fig. 31: Parameter window “Channel A, general” switch sensor operating mode

Connected contact type

Options: normally open/ normally closed

Option *normally open* = input normally open when actuated.

Option *normally closed* = input normally closed when actuated.

Long operation after... time base

Options: 100ms/1s/10s/1 min/10min/1 h

Defines the period T_L after which an operation is interpreted as “long”.
($T_L = \text{time base} \times \text{factor}$)

Factor [1...255]

Options: 1...10...255

3.2.2.2 Parameter window “Channel A, switch sensor”

The following parameters are visible in the parameter window “Channel A, switch sensor” if the option *no* has been selected with the parameter *Distinction between long and short operation*.

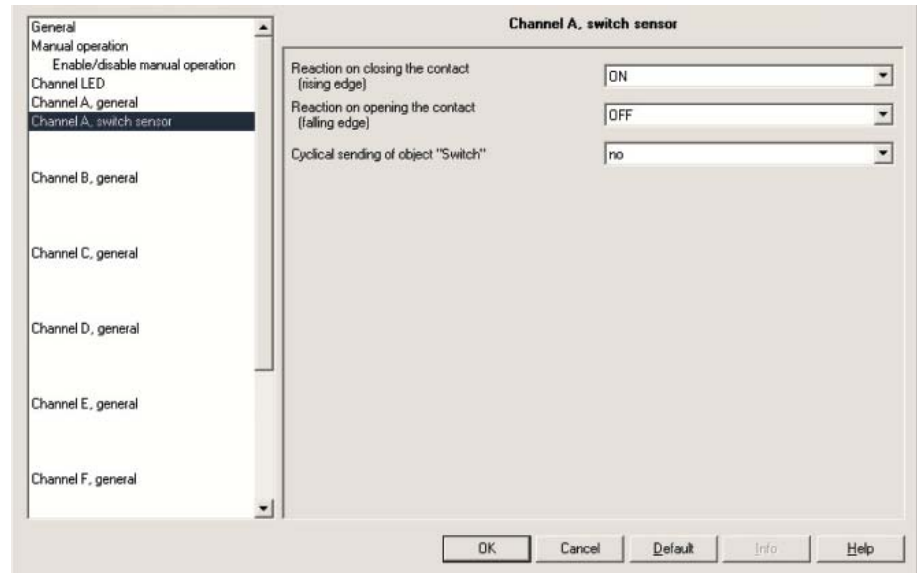

Fig. 32: Parameter window “Channel A, switch sensor” operating mode

Reaction when closing the contact (rising edge)

Options: ON/
OFF/
TOGGLE/
no reaction/
stop cyclic sending

Reaction when opening the contact (falling edge)

Options: ON/
OFF/
TOGGLE/
no reaction/
stop cyclic sending

For each edge it is possible to set if the object value is to be switched *ON*, *OFF* or *TOGGLE*, or if *no reaction* should occur.

If the option *yes* is selected in the parameter *Cyclical sending of object "Switch"* is selected, the following parameter appears.

Cyclical sending of object "Switch"

Options: no/
if "switch" = ON/
if "switch" = OFF/
always

Option if "Switch" = ON = object value is sent cyclically

Option if "Switch" = OFF = object value is sent cyclically

Option *always* = communication object "Switch" is sent cyclically

What is cyclic sending?

Cyclic sending enables the communication object "Switch" to send automatically at a fixed interval.

If cyclical sending is only carried out for a specific object value (ON or OFF), this condition refers to the value of the communication object. It is therefore possible in principle to start the cyclical sending by sending a value to the communication object "Switch. As this reaction is generally unwanted, the "write" flag and "update" flag of the communication object have to be deleted in the setting to ensure that it cannot be changed via the bus. If however this functionality is required, the flags must be set accordingly.

When the "Switch" object changes and after bus voltage recovery (once the transmission delay has elapsed), the object value is sent immediately on the bus and the transmission cycle time restarts.

The next two parameters are only visible if the options *ON*, *OFF* or *always* in the *cyclical sending of object "Switch"* have been selected.

Telegram is repeated every ... ("sending cycle time"): base

Options: 1 s/10 s/1 min/10 min/1 h

The cycle time for sending describes the interval between two cyclically sent telegrams.

Cycle time for sending = time base x factor.

Factor [1...255]

Options: 1...30...255

3.2.2.3 Parameter window “Channel A, switch sensor”

The following parameters are visible in the parameter window “Channel A, switch sensor” if the option *yes* has been selected with the parameter *Distinction between long and short operation*.

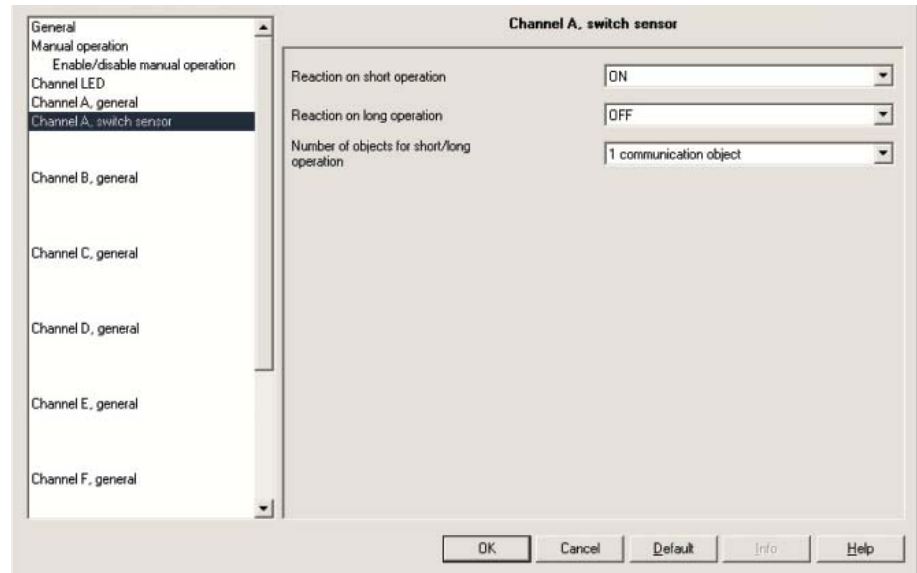

Fig. 33: Parameter window “Channel A, switch sensor” operating mode

“Reaction on short operation”

Options: ON/
OFF/
TOGGLE/
no reaction

“Reaction on long operation”

Options: ON/
OFF/
TOGGLE/
no reaction

For every operation (short or long) it is set if the object value is *ON*, *OFF* or *TOGGLE*, or if *no reaction* should occur. The object value is updated as soon as it has been determined if a short or long operation has occurred.

“Number of objects for short/long operation”

Options: 1 communication object/
2 communication objects

In order to differentiate between long and short operation, a further communication object can be released by the option *2 communication objects*. This communication object reacts exclusively to long operations.

3.2.3 Operating mode fault signal input

The “fault signal input” operating mode is described in the following.

Note: The options need to be adjusted in the standard setting for the fault signal input operating mode. The options for the fault signal input must be listed individually. Furthermore, only the parameters which are relevant for an optimum fault signal input are described. All other parameters are described in the “switch sensor” operating mode.

3.2.3.1 Parameter window “Channel A, general”

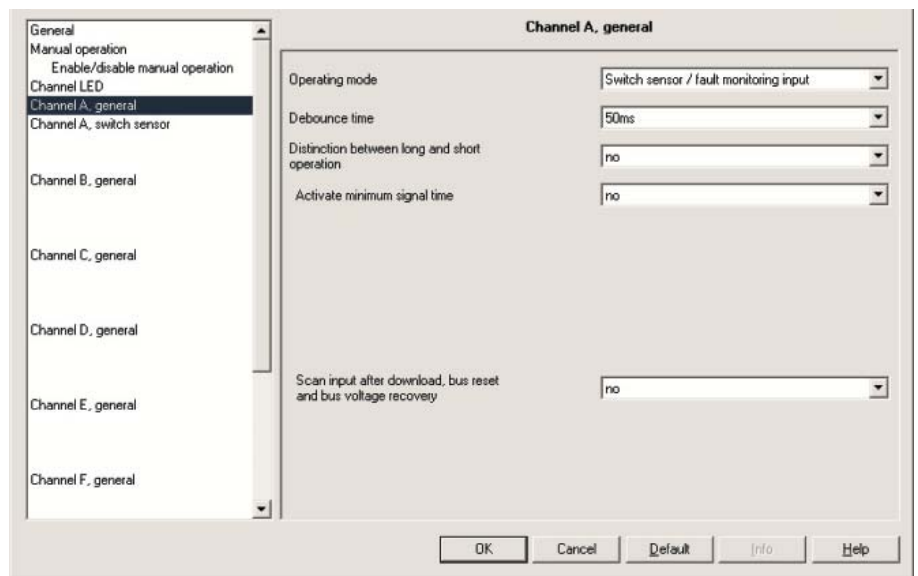

Fig. 34: Parameter window “Channel A, general” fault signal input operating mode

Debounce time

Options: 10ms/20ms/30ms/50ms/70ms/100ms/150ms

Fault signal option: 50ms

Debouncing prevents unwanted multiple operation of the input, e.g. due to bouncing of the contact.

What is debounce time?

If a pulse edge is detected at the input, the input reacts to it immediately (e.g. by sending a telegram). The debounce time T_D starts simultaneously. The signal at the input is not evaluated within the debounce period.

The following example illustrates this:

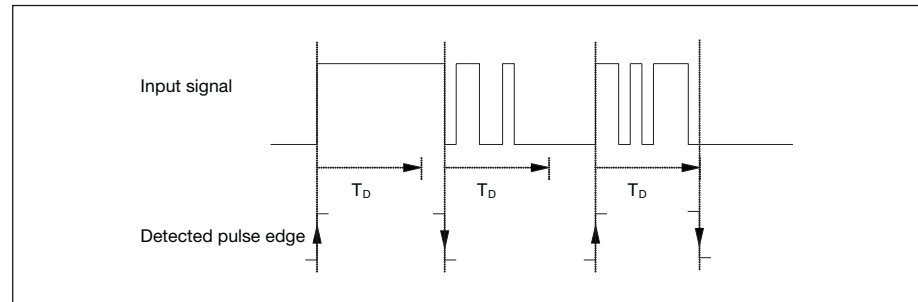

Fig. 35: Debounce time of the input signal on the edge to be recognised

Once a pulse edge has been detected at the input, further edges are ignored for the duration of the debounce time T_D .

Distinction between long and short operation

Options: yes/no

Fault signal option: no

This parameter defines whether the input distinguishes between a short and long operation.

If yes is selected, there is a delay after opening/closing the contact to determine whether there is a short or long operation. Only then is a possible reaction triggered.

The following diagram illustrates the function:

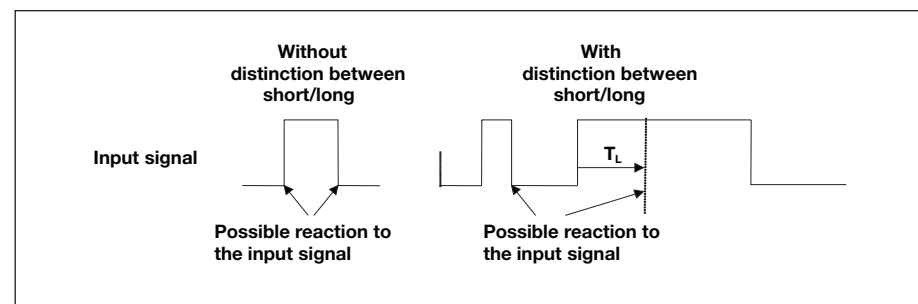

T_L is the period after which a push button action is recognised as a long operation.

Fig. 36: Distinction between short/long operation for "Switch sensor" function

Note: If it is not possible to detect the debounce time of the fault signal contacts being monitored, the reaction of the input signal must be tested with the "no" position.

The following parameters are visible in the parameter window “Channel A, general” if the option no has been selected with the parameter *Distinction between long and short operation*.

Activate minimum signal time

Options: yes/no

Fault signal option: yes

The minimum signal time defines the time for which a fault signal must be present so that a reaction is possible or sent.

What is minimum signal time?

This function differs from the debounce time by the fact that the telegram is sent only after the minimum signal time has timed out. The functions in detail:

If an edge is detected at the input, the minimum signal time commences. No telegram is sent on the bus during this time. The signal at the input is monitored within the minimum signal time. If a further edge is detected at the input during the minimum signal time, this is interpreted as a renewed actuation and the minimum signal time starts if necessary.

If the input signal has not changed during the minimum signal time an edge is detected and a telegram is sent on the bus if necessary.

The following example illustrates this:

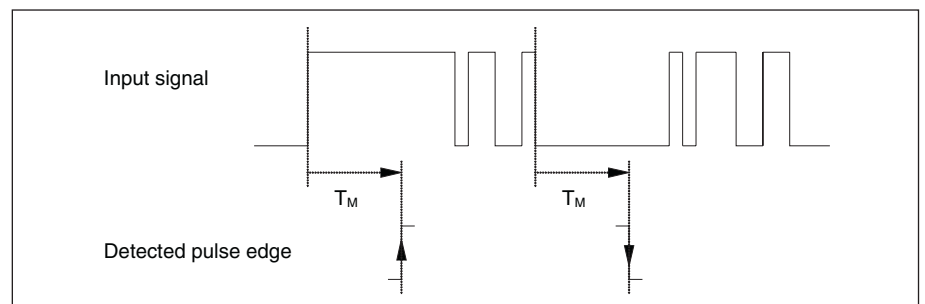

Fig. 37: Minimum signal time of the input signal on the edge to be recognised

Since only two pulse edges remain stable for the duration of the minimum signal time T_M, only these pulse edges are recognised as valid.

Scan input after download, bus reset and bus voltage recoveryOptions: yes/no

Fault signal option: yes

Option *yes* = object value is scanned after download, bus reset and bus voltage recovery.

Option *no* = object value is not scanned after download, bus reset and bus voltage recovery.

If the option *yes* is selected in the parameter *Scan input after download, bus reset and bus voltage recovery after download*, the following parameter becomes visible.

Inactive wait state after bus voltage recovery**[0...30.000s, 0=inactive]**Options: 0...30.000

This parameter is used to set the waiting time after bus voltage recovery.

The following drawing indicates the sequence involved:

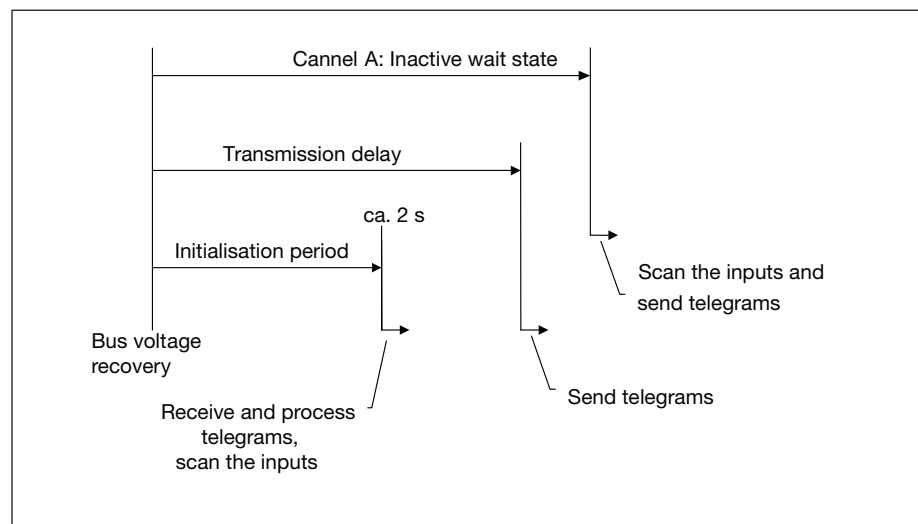

Fig. 38: Behaviour after voltage recovery with inactive wait state

The inputs are scanned and the object values are updated accordingly – if possible – as soon as the bus voltage recovers after the initialisation time (approx. 2s). If an input has been actuated, the device will react as if the actuation has commenced at the end of the initialisation time.

The state at the input terminals is detected after this time has timed out. The input reacts as if the state at the input terminals has just been set/not set.

Note: The inactive wait state should be smaller than the transmission delay time. The inactive wait state does not add to the adjustable delay time for sending.

If the option *yes* is selected with the parameter *Activate minimum signal time*, the following parameters are visible.

Note: Depending on the system type, it is recommended to set a minimum signal time, for example, of 2s. With the evaluation, for example, of coupling switches, generator switches or incoming circuit-breakers from switchgear systems, a minimum signal time of less than 100 ms may be required.

After rising edge: time base

Options: 100ms/1s/10s/1 min/10min/1 h

Fault signal option: 1s

After rising edge corresponds to a “normally opened” function.

Factor [1...255]

Options: 1...10...255

Fault signal option: 2

After falling edge: time base

Options: 100ms/1s/10s/1min/10min/1 h

Fault signal option: 1s

After falling edge corresponds to a “normally closed” function.

Factor [1...255]

Options: 1...10...255

Fault signal option: 2

Note: It is absolutely essential to match the switching times with the user.
Depending on the system, even lower signal times (switching times) may be required.

3.2.3.2 Parameter window “Channel A, switch sensor” for a fault signal input

If the option *no* has been selected with the parameter *Distinction between long and short operation* the following parameters are visible in the parameter window “Channel A, switch sensor”.

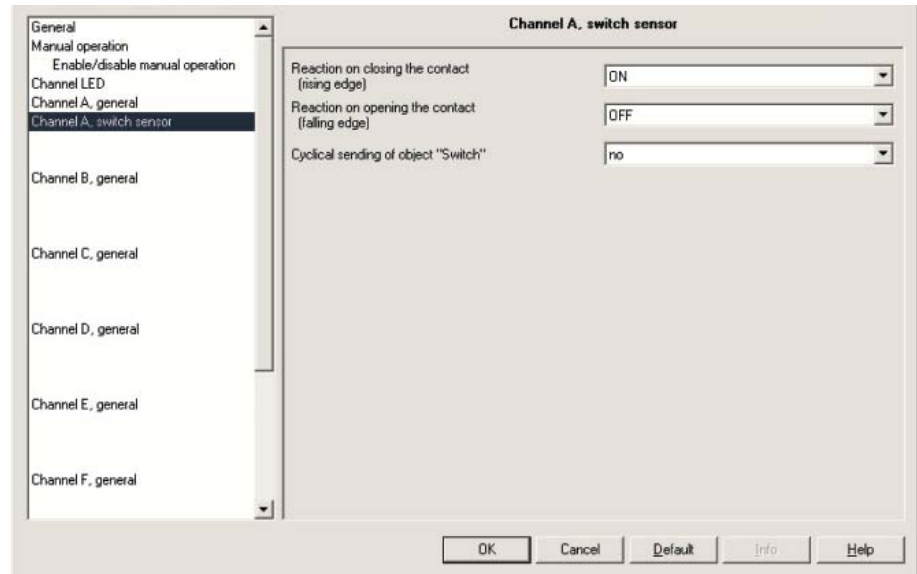

Fig. 39: Parameter window “Channel A, switch sensor” operating mode for a fault signal input

Reaction when closing the contact (rising edge)

Options: ON/
OFF/
TOGGLE/
no reaction/
stop cyclic sending

Fault signal option: Adjustable to suit

Reaction when opening the contact (falling edge)

Options: ON/
OFF/
TOGGLE/
no reaction/
stop cyclic sending

Fault signal option: Adjustable to suit

For each edge it is possible to set if the object value is to be switched *ON*, *OFF* or *TOGGLE* or if *no reaction* should occur.

If the option *yes* is selected in the parameter *Cyclical sending of object "Switch"* is selected, the following parameter appears.

Cyclical sending of object "Switch"

Options: no/
if "Switch" = ON
if "Switch" = OFF/
always

Fault signal option: always

Option *if "Switch" = ON* = object value is sent cyclically

Option *if "Switch" = OFF* = object value is sent cyclically

Option *always* = communication object "Switch" is sent cyclically

What is cyclic sending?

Cyclic sending enables the communication object "Switch" to send automatically at a fixed interval.

If cyclical sending is only carried out for a specific object value (ON or OFF), this condition refers to the value of the communication object. It is therefore possible in principle to start the cyclical sending by sending a value to the communication object "Switch". As this reaction is generally unwanted, the "write" flag and "update" flag of the communication object have to be deleted in the setting to ensure that it cannot be changed via the bus. If however this functionality is required, the flags must be set accordingly.

When the "Switch" object changes and after bus voltage recovery (once the transmission delay has elapsed), the object value is sent immediately on the bus and the transmission cycle time restarts.

The next two parameters are only visible if the options *ON*, *OFF* or *always* in the *cyclical sending of object "Switch"* have been selected.

Telegram is repeated every ... ("sending cycle time"): time base

Options: 1 s/10 s/1 min/10 min/1 h

Fault signal option: 1 s

The cycle time for sending describes the interval between two cyclically sent telegrams.

Cycle time for sending = time base x factor.

Factor [1...255]

Options: 1...30...255

Fault signal option: 30

3.2.3.3 Communication objects
“Channel A”

Number	Object Function	Name	Length	C	R	W	T	U
10	Blocking	Channel A, switch ...	1 bit	C	-	W	-	-
11	Switch	Channel A, switch ...	1 bit	C	-	W	T	-
12	Switch - long	Channel A, switch ...	1 bit	C	-	-	T	-

Fig. 40: Communication object “Channel A” switch sensor operating mode

No.	Function	Object name	Data type	Flags
10	Block	Channel A, switch sensor	EIS 1, 1 bit DTP 1.003	C, W
<p>Telegram value “0” enable Channel A “1” block Channel B</p> <p>Via the “Block” communication object the channel connection can be blocked or released. A telegram is sent to the bus if a blocked channel is released. With activated “Blocked” communication object the inputs and the “manual operation” are blocked.</p> <p>Note: There is generally no reaction when a channel is blocked but</p> <ul style="list-style-type: none"> - with all operating modes waiting for a long button push or minimum signal duration is aborted - with the Switch/dimming sensor and Shutter sensor mode cyclic sending is interrupted - with the Control scene mode saving ends <p>during the blocking of a channel,</p> <ul style="list-style-type: none"> - a signal change on the terminals or with manual operation is ignored - communication objects are still updated and sent if necessary <p>If a channel is enabled a change of the signal states (compared to blocking) leads to immediate processing, e.g.</p> <ul style="list-style-type: none"> - start the minimum actuation or detection of a long/short button push - communication objects are sent if necessary 				
11	Switch	Channel A, switch sensor	EIS1, 1 bit DTP 1.001	C, W, T
<p>Telegram value “0” OFF “1” ON</p> <p>In accordance with the parameter setting, this communication object can be switched by actuation of the ON, OFF or TOGGLE input. With TOGGLE the previous value e.g. “1” is switched directly to the value “0”. The communication object can send cyclically, e.g. monitoring the life signs of the sensor. It is important to ensure that the communication object can be written to externally. Thus, cyclical send is interrupted or not possible.</p>				
12	Switch long	Channel A, switch sensor	EIS1, 1 bit DTP 1.001	C, T
<p>Telegram value “0” No “1” Yes</p> <p>This communication object is only visible if the parameter <i>Distinction between long and short operation = yes</i>, and the parameter <i>Number of objects for short/long operation = 2 communication objects</i>. This additional communication object is assigned to the long operation. The communication object Channel A, switch sensor – Switch now no longer reacts to a long operation.</p>				
13 ... 19	not assigned			

Table 17: Communication objects 10 to 19 “Channel A” switch sensor operating mode

3.2.3.4 Communication objects “Channel B to H”

No.	Function	Object name	Data type	Flags
20 ... 29	Analogue 10...19 Channel A switch sensor	Channel B		
30 ... 39	Analogue 10...19 Channel A switch sensor	Channel C		
40 ... 49	Analogue 10...19 Channel A switch sensor	Channel D		
50 ... 59	Analogue 10...19 Channel A switch sensor	Channel E		
60 ... 69	Analogue 10...19 Channel A switch sensor	Channel F		
70 ... 79	Analogue 10...19 Channel A switch sensor	Channel G		
80 ... 89	Analogue 10...19 Channel A switch sensor	Channel H		

Table 18: Communication objects 20 to 89 “Channel B to H” switch sensor operating mode

3.2.4 Operating mode switch/dimming sensor

The operating mode allows the operation of dimmable lighting.

Note: The standard settings for the options are underlined, e.g. option: yes/no.

3.2.4.1 Parameter window “Channel A, general”

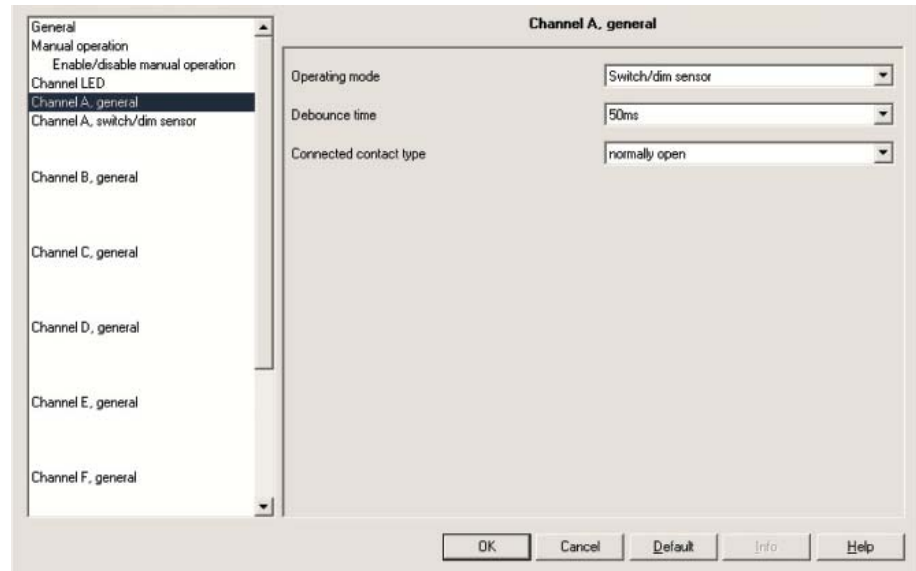

Fig. 41: Parameter window “Channel A, general” switch/dimming sensor operating mode

Debounce time

Options: 10ms/20ms/30ms/50ms/70ms/100ms/150ms

Debouncing prevents unwanted multiple operation of the input, e.g. due to bouncing of the contact.

What is debounce time?

If a pulse edge is detected at the input, the input reacts to it immediately (e.g. by sending a telegram). The debounce time T_D starts simultaneously. The signal at the input is not evaluated within the debounce period.

The following example illustrates this:

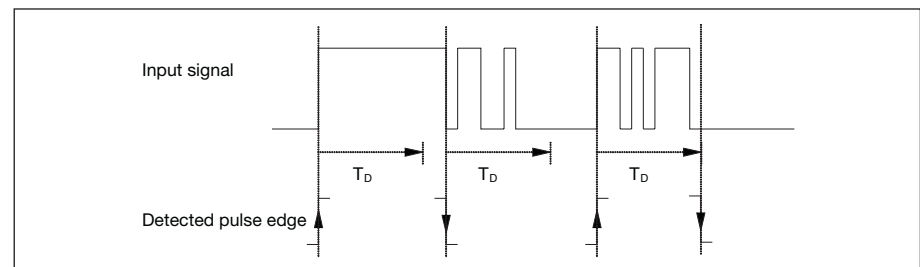

Fig. 42: Debounce time of the input signal on the edge to be recognised

Once a pulse edge has been detected at the input, further edges are ignored for the duration of the debounce time T_D .

Connected contact type

Options: normally open/ normally closed

Here you set if the input contact is an normally closed (break) or normally open (make) contact.

3.2.4.2 Parameter window
“Channel A, switch/
dimming sensor”

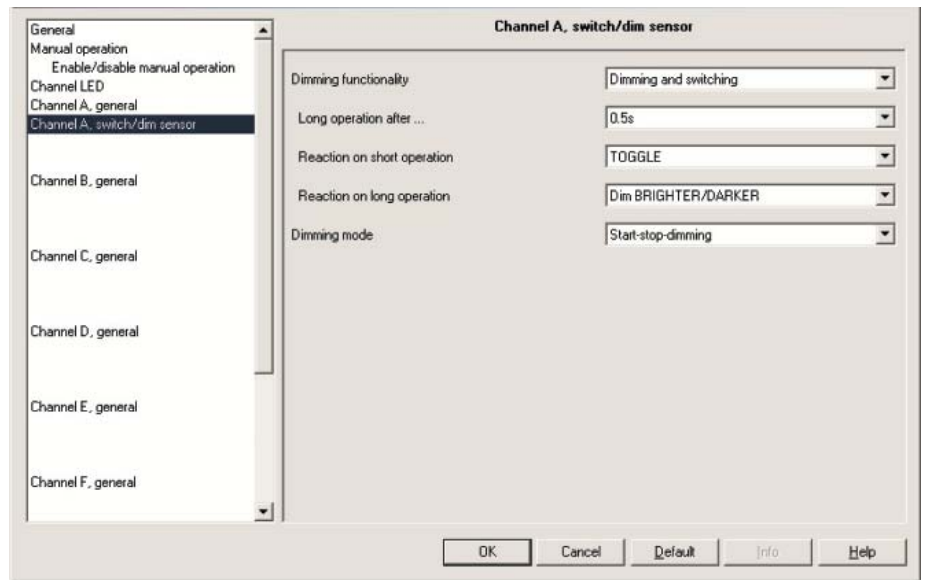

Fig. 43: Parameter window “Channel A, switch/dimming sensor” operating mode

Dimming function

Options: Dimming and switching/
Only dimming

This parameter is used to define if the lighting can be dimmed (*Only dimming*) or if addition switching is also permitted (*Dimming and switching*). In this case a long operation actuated dimming and a short operation actuates switching.

How does 1 button dimming function?

Switching and dimming functions can be fully controlled via a single push button. Each dim actuation is sent alternately with a BRIGHTER or DARKER dim telegram.

If the communication object “Switch” = 0, a BRIGHTER telegram is sent at all times. In order to evaluate the switch feedback of the actuator, the “Write” flag of the communication object “Switch” is set.

The following table illustrates the function in detail:

Object value “Switch”	Value of the last dimming telegram	Reaction to the dimming operation (dimming telegram sent)
OFF	DARKER	BRIGHTER
OFF	BRIGHTER	BRIGHTER
ON	DARKER	BRIGHTER
ON	BRIGHTER	DARKER

Table 19: Dimming function “1 button dimming”

The advantage of the “Only dimming” function is that no distinction is made between short and long actuation. The dim command is issued immediately on actuation. It is not necessary to wait for a long actuation.

How does 2 button dimming function?

If “2 button dimming” is required, the function of the individual button must be set (e.g. “ON” or “Dim BRIGHTER”) with the parameters “Reaction to long or short operation”.

The user thus has complete freedom to choose which push buttons are combined with one another in order to dim a group of luminaries, or which function the individual push button has in this case.

Furthermore, 2 button dimming requires 2 channels, e.g. Channel A with short operation for switch on and long operation for dim brighter. Channel B with short operation for switch off and long operation for dim darker.

If the option *Switching and dimming* is selected with the *Dimming functionality*, the parameters *long operation*,..., *Reaction on short...* and *Reaction on long...* are visible in the parameter window “Channel A, switch/dimming sensor”.

Long operation after...

Options: 0.3s/0.4s/0.5s/0.6s/0.8s/1 s/1.2s/1.5s/2s/3s/4s/
5s/6s/7s/8s/9s/10s

Defines the period T_L after which an operation is interpreted as “long”.

Reaction on short operation

Options: ON/
OFF/
TOGGLE/
no reaction

A short operation changes the value of the communication object “Telegram switch”. This parameter sets if the communication object “Telegram switch” TOGGLES with short operation (typically: 1 button dimming) or only switches ON or OFF (typically: 2 button dimming).

Reaction on long operation

Options: Dim BRIGHTER/
Dim DARKER/
Dim BRIGHTER/DARKER

A long operation changes the value of the communication object “Telegram Dimming”. With this parameter you determine if the communication object “Dimming” sends a BRIGHTER or DARKER telegram with long operation. With 1 button dimming the parameter “Dim BRIGHTER/DARKER” must be set. In this case the dim command which is the opposite to the last dim command is set.

The following parameters are visible in the parameter window if the option *Only dimming* is selected in the *Dimming function* instead of *Reaction on short operation* and *Reaction on long operation*.

Reaction on operation

Options: Dim BRIGHTER/
Dim DARKER/
Dim BRIGHTER/DARKER

With this parameter you determine if the communication object “Dimming” sends a BRIGHTER or DARKER telegram with long operation. With 1 button dimming the parameter “Dim BRIGHTER/DARKER” must be set. In this case the dim command opposite to the last dim command is set.

Dimming mode

Options: Start-stop-dimming/
Dimming steps

Normal *Start-stop-dimming* starts the dimming mode with a brighter or darker telegram and ends the dimming mode with a Start-stop-dimming telegram.

4-Bit dimming command:

Dec.	Hex.	Binary	Dim command
0	0	0000	Stop
1	1	0001	100 % darker
8	8	1000	Stop
9	9	1001	100 % brighter

Table 20: 4 bit dim command for start-stop dimming

A table with further 4-Bit-Values can be found in the Appendix.

With *Dimming steps* the dimming telegram is sent cyclically during a long operation. The stop telegram ends the dimming process at the end of operation.

The next two parameters are only visible if the *Dimming steps* option is set in the *Dimming mode* parameter.

Brightness change on every sent telegram

Options: 100 %/50 %/25 %/12.5 %/6.25/3.13 %/1.56 %

This parameter is set to change the brightness (in percent) which is cyclically sent with every Dim telegram.

Cycle time for sending: Telegram is repeated every ...

Options: 0.3s/0.4s/0.5s/0.6s/0.8s/1 s/1.2s/1.5s/2s/3s/4s/
5s/6s/7s/8s/9s/10s

The dimming telegram is sent cyclically during a long operation. The cycle time for sending corresponds with the time interval between two telegrams during cyclical sending.

3.2.4.3 Communication objects
“Channel A”

Number	Object Function	Name	Length	C	R	W	T	U
10	Blocking	Channel A, switch...	1 bit	C	-	W	-	-
11	Switch	Channel A, switch...	1 bit	C	-	W	T	-
12	Dimming	Channel A, switch...	4 bit	C	-	-	T	-

Fig. 44: Communication object “Channel A” switch/dimming sensor operating mode

No.	Function	Object name	Data type	Flags
10	Block	Channel A, switch/dimming sensor	EIS 1, 1bit DTP 1.003	C, W
<p>Telegram value “0” enable Channel A “1” block Channel A</p> <p>Via the “Block” communication object the channel connection can be blocked or released. A telegram is sent to the bus if a blocked channel is released. With activated “Blocked” communication object the inputs and the “manual operation” are blocked.</p> <p>Note: There is generally no reaction when a channel is blocked but</p> <ul style="list-style-type: none"> - with all operating modes waiting for a long button push or minimum signal duration is aborted - with the Switch/dimming sensor and Shutter sensor mode cyclic sending is interrupted - with the Control scene mode saving ends <p>during the blocking of a channel,</p> <ul style="list-style-type: none"> - a signal change on the terminals or with manual operation is ignored - communication objects are still updated and sent if necessary <p>If a channel is enabled a change of the signal states (compared to blocking) leads to immediate processing, e.g.</p> <ul style="list-style-type: none"> - start the minimum actuation or detection of a long/short button push - communication objects are sent if necessary 				
11	Switch	Channel A, switch/dimming sensor	EIS1, 1bit DTP 1.001	C, W, T
<p>Telegram value “0” OFF “1” ON</p> <p>This communication object is only visible if the “Dimming and switching” value has been set in the Dimming function parameter.</p> <p>The object value can be switched to ON, OFF or TOGGLE in accordance with the parameter with a short operation. With TOGGLE the previous value e.g. “1” is switched directly to the value “0”. During dimming the communication object should be connected to the switch feedback of the dimming actuator as a non-sending group address. (Update of the switching state).</p>				
12	Dimming	Channel A, switch/dimming sensor	EIS2, 4bit DTP 3.007	C, T
<p>A long operation at the input has the effect that a “BRIGHTER” or “DARKER” dim command is sent via this communication object on the bus. A Stop command is sent as soon as the operation at the input is discontinued.</p>				
13	not assigned			
...				
19				

Table 21: Communication objects 10 to 19 “Channel A” switch/dimming sensor operating mode

3.2.4.4 Communication objects
“Channel B to H”

No.	Function	Object name	Data type	Flags
20 ... 29	Analogue 10...19 Channel A Switch/dimming sensor	Channel B		
30 ... 39	Analogue 10...19 Channel A Switch/dimming sensor	Channel C		
40 ... 49	Analogue 10...19 Channel A Switch/dimming sensor	Channel D		
50 ... 59	Analogue 10...19 Channel A Switch/dimming sensor	Channel E		
60 ... 69	Analogue 10...19 Channel A Switch/dimming sensor	Channel F		
70 ... 79	Analogue 10...19 Channel A Switch/dimming sensor	Channel G		
80 ... 89	Analogue 10...19 Channel A Switch/dimming sensor	Channel H		

Table 22: Communication objects 20 to 89 “Channel B to H” switch/dimming sensor operating mode

3.2.5 Shutter sensor mode

The function enables the operation of blinds and shutters with push buttons or switches.

Note: The standard settings for the options are underlined, e.g. option: yes/no.

3.2.5.1 Parameter window “Channel A, general”

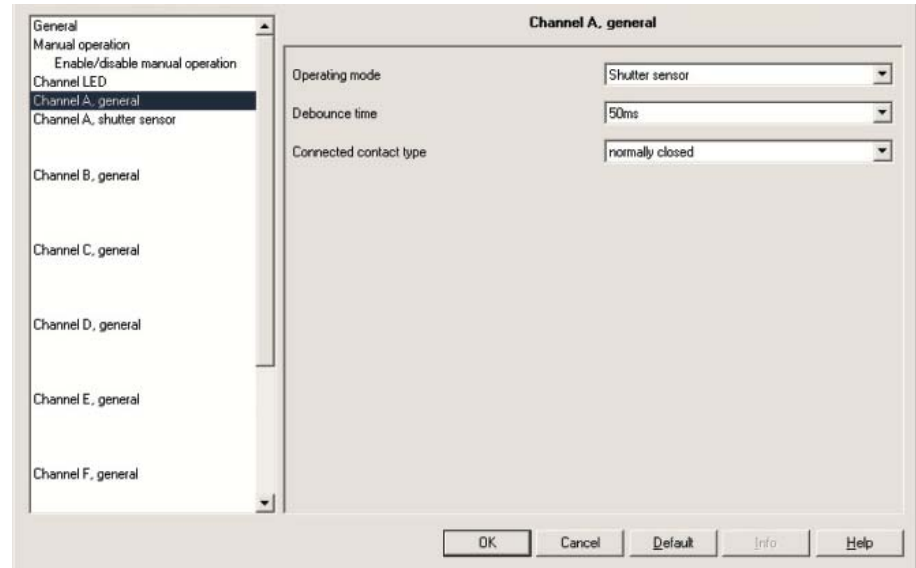

Fig. 45: Parameter window “Channel A, general” shutter sensor operating mode

Debounce time

Options: 10ms/20ms/30ms/50ms/70ms/100ms/150ms

Debouncing prevents unwanted multiple operation of the input, e.g. due to bouncing of the contact.

What is debounce time?

If a pulse edge is detected at the input, the input reacts to it immediately (e.g. by sending a telegram). The debounce time T_D starts simultaneously. The signal at the input is not evaluated within the debounce period.

The following example illustrates this:

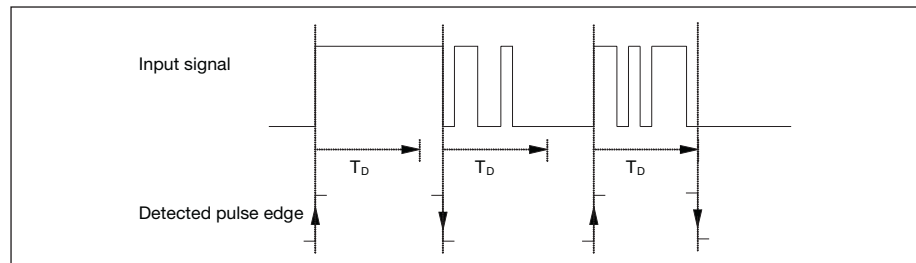

Fig. 46: Debounce time from input signal to detected edge

Once a pulse edge has been detected at the input, further edges are ignored for the duration of the debounce time T_D .

Connected contact type

Options: normally open/ normally closed

Here you set if the input contact is an normally closed (break) or normally open (make) contact.

3.2.5.2 Parameter window “Channel A, shutter sensor”

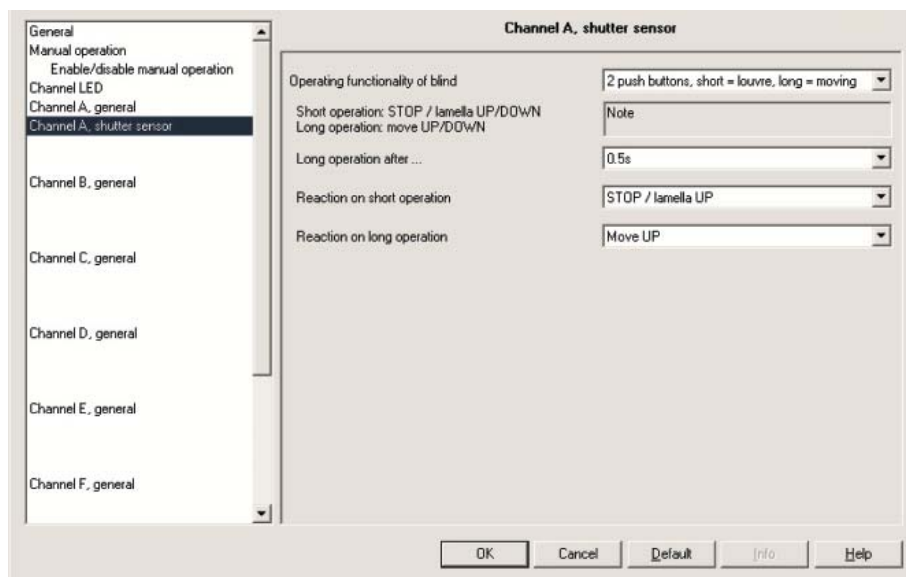

Fig. 47: Parameter window “Channel A, shutter sensor” operating mode

Shutter operating function

- Options:
- 1 push button, (short = stepping, long = moving)/
 - 1 push button, (short = moving, long = stepping)/
 - 1 push button, (moving/stopping only)/
 - 1 switch, moving only/
 - 2 push buttons, (short = louvre, long = moving)/
 - 2 switches, moving only /
 - 2 push buttons, moving/stopping only/
 - 2 push buttons, louvre adjustment only

The following tables provide an overview of the shutter operating functions:

1 push button, (short = stepping, long = moving)	
Short operation	Stop/lamella adjustment; Opposite direction to the last movement command* To return to lamella adjustment, the blind must be raised or lowered briefly.
Long operation	Alternately "MOVE UP" or "MOVE DOWN"
1 push button, short = moving, long = stepping	
Short operation	Alternately "MOVE UP" or "MOVE DOWN"
Long operation	STOP/lamella adjustment (cyclical sending); Opposite direction to the last movement or stepping command*
1 push button, moving / stopping only	
On operation	The following commands are sent in sequence: ... → "MOVE UP" → "STOP / lamella UP" → "MOVE DOWN" → "STOP / lamella DOWN" → ... *
1 switch, moving only	
Start of operation	Alternately "MOVE UP" or "MOVE DOWN"
End of operation	STOP / lamella adj. *
2 push button, standard (short = stepping, long = moving)	
Short operation	"STOP/lamella UP" or "... DOWN" (programmable)
Long operation	"MOVE UP" or "MOVE DOWN" (programmable)
2 switches, moving only	
Start of operation	"MOVE UP" or "MOVE DOWN" (programmable)
End of operation	"STOP/lamella UP" or "... DOWN" (programmable)
2 push buttons, moving / stopping only	
On operation	The following commands are sent in sequence: ... → "MOVE UP" → "STOP / lamella UP" → ... or ... → "MOVE DOWN" → "STOP / lamella UP" → ...
2 push buttons, louvre adjustment only	
On operation	"STOP / lamella adj. UP" or "... DOWN"

Table 23: Various shutter operating functions

*** Note:** If the actuator signals the limit position, the communication object can be synchronised in 1 button operation. If the actuator is in the limit position (see objects "Upper limit position" or "Lower limit position"), the direction of movement is preselected. In "1 push button/switch operation", the last direction of movement is determined via the last update of the communication object "Shutter UP/DOWN".

Differing parameters appear depending on the selection you have made in the parameter Operating functionality of blind. All parameters are described in the following.

Long operation after...

Options: 0.3s/0.4s/0.5s/0.6s/0.8s/1 s/1.2s/1.5s/2s/3s/4s/
5s/6s/7s/8s/9s/10s

Defines the period T_L after which an operation is interpreted as “long”.

Telegram “STOP/lamella adj.” is repeated every...

Options: 0.3s/0.4s/0.5s/0.6s/0.8s/1 s/1.2s/1.5s/2s/3s/4s/
5s/6s/7s/8s/9s/10s

The interval between two “lamella” telegrams is set here.

Reaction on short operation

Options: STOP / lamella UP/
STOP / lamella DOWN

Reaction on long operation

Options: Move UP/
Move DOWN

It can be set whether the input triggers commands for movement upwards (“UP”) or downwards (“DOWN”).

Reaction on operation

Options: Move UP/
Move DOWN

It can be set whether the input triggers commands for movement upwards (“Move UP”) or downwards (“Move DOWN”).

3.2.5.3 Communication objects
“Channel A”

Number	Object Function	Name	Length	C	R	W	T	U
10	Blocking	Channel A, shutter sensor	1 bit	C	-	W	-	-
11	Shutter UP/DOWN	Channel A, shutter sensor	1 bit	C	-	W	T	-
12	STOP / lamella adj.	Channel A, shutter sensor	1 bit	C	-	-	T	-
13	Upper limit position	Channel A, shutter sensor	1 bit	C	-	W	-	-
14	Lower limit position	Channel A, shutter sensor	1 bit	C	-	W	-	-

Fig. 48: Communication objects “Channel A” shutter sensor operating mode

No.	Function	Object name	Data type	Flags
10	Block	Channel A Shutter sensor	EIS 1, 1 bit DTP 1.003	C, W
<p>Telegram value “0” Release Channel A “1” Disable Channel A</p> <p>Via the “Block” communication object the channel connection can be blocked or released. A telegram is sent to the bus if a blocked channel is released. With activated “Blocked” communication object the inputs and the “manual operation” are blocked.</p> <p>Note: There is generally no reaction when a channel is blocked but</p> <ul style="list-style-type: none"> - with all operating modes waiting for a long button push or minimum signal duration is aborted - with the Switch/dimming sensor and Shutter sensor mode cyclic sending is interrupted - with the Control scene mode saving ends <p>during the blocking of a channel,</p> <ul style="list-style-type: none"> - a signal change on the terminals or with manual operation is ignored - communication objects are still updated and sent if necessary <p>If a channel is enabled a change of the signal states (compared to blocking) leads to immediate processing, e.g.</p> <ul style="list-style-type: none"> - start the minimum actuation or detection of a long/short button push - communication objects are sent if necessary 				
11	Shutter UP/DOWN	Channel A Shutter sensor	EIS7, 1 bit DTP 1.008	C, W, T
<p>This communication object sends a shutter motion command (UP or DOWN) to the bus. The device also detects movement commands of other sensors when telegrams are received (e.g. parallel operation).</p>				
12	Stopp/STOP / lamella adjustment	Channel A Shutter sensor	EIS7, 1 bit DTP 1.007	C, T
<p>Telegram value “0” Stop/lamella UP “1” Stop/lamella DOWN</p> <p>This communication object sends a stop command or lamella adjustment</p>				
13	Upper limit position	Channel A Shutter sensor	EIS1, 1 bit DTP 1.002	C, W
<p>Telegram value “0” no upper end limit “1” at upper end limit</p> <p>Via this communication object, the shutter actuator reports whether or not it is in the upper limit position (“shutter open”).</p> <p>Note: The communication object is import and for 1 button operation.</p>				
14	Lower limit position	Channel A Shutter sensor	EIS1, 1 bit DTP 1.002	C, W
<p>Telegram value “0” no lower end limit “1” at lower end limit</p> <p>Via this communication object, the shutter actuator reports whether or not it is in the lower limit position (“shutter closed”).</p> <p>Note: The communication object is important for 1 button operation.</p>				
15	not assigned			
...				
19				

Table 24: Communication objects 10 to 19 “Channel A” shutter sensor operating mode

3.2.5.4 Communication objects
“Channel B to H”

No.	Function	Object name	Data type	Flags
20 ... 29	Analogue 10...19 Channel A Shutter sensor	Channel B		
30 ... 39	Analogue 10...19 Channel A Shutter sensor	Channel C		
40 ... 49	Analogue 10...19 Channel A Shutter sensor	Channel D		
50 ... 59	Analogue 10...19 Channel A Shutter sensor	Channel E		
60 ... 69	Analogue 10...19 Channel A Shutter sensor	Channel F		
70 ... 79	Analogue 10...19 Channel A Shutter sensor	Channel G		
80 ... 89	Analogue 10...19 Channel A Shutter sensor	Channel H		

Table 25: Communication objects 20 to 89 “Channel B to H” shutter sensor operating mode

**3.2.6 Operating mode
Value/forced operation**

The function permits the values of any data types to be sent.

Note: The standard settings for the options are underlined, e.g. option: yes/no.

**3.2.6.1 Parameter window
“Channel A, general”**

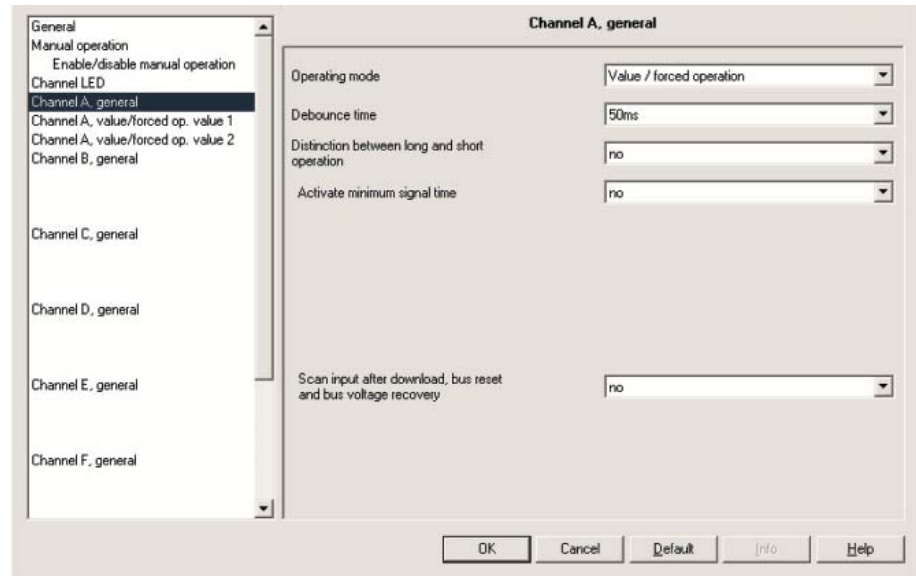

Fig. 49: Parameter window “Channel A, general” value/forced operation operating mode

Debounce time

Options: 10ms/20ms/30ms/50ms/70ms/100ms/150ms

Debouncing prevents unwanted multiple operation of the input, e.g. due to bouncing of the contact.

What is debounce time?

If a pulse edge is detected at the input, the input reacts to it immediately (e.g. by sending a telegram). The debounce time T_D starts simultaneously. The signal at the input is not evaluated within the debounce period.

The following example illustrates this:

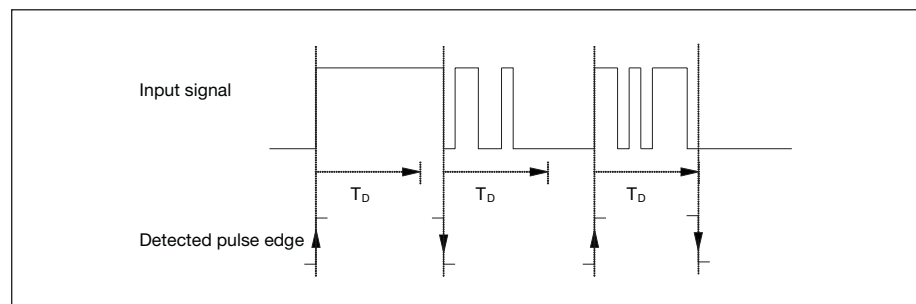

Fig. 50: Debounce time from input signal to detected edge

Once a pulse edge has been detected at the input, further edges are ignored for the duration of the debounce time T_D .

Distinction between long and short operation

Options: yes/no

This parameter defines whether the input distinguishes between a short and long operation.

If yes is selected, there is a delay after opening/closing the contact to determine whether there is a short or long operation. Only then is a possible reaction triggered.

Note: When there is a distinction between a short and long operation, 2 objects are visible per channel. One communication object only sends after a short operation while the other communication object only sends after a long operation.

The following diagram illustrates the function:

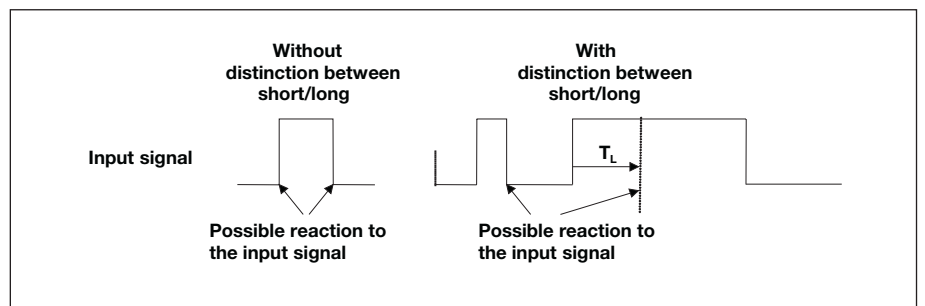

T_L is the period after which a push button action is recognised as a long operation.

Fig. 51: Distinction between short/long operation for "Value/forced operation" function

The following parameters are visible in the parameter window “Channel A, general” if the option *no* has been selected with the parameter *Distinction between short/long operation*.

Activate minimum signal time

Options: yes/ no

What is minimum signal time?

This function differs from the debounce time by the fact that the telegram is sent only after the minimum signal time has timed out. The functions in detail:

If an edge is detected at the input, the minimum signal time commences. No telegram is sent on the bus during this time. The signal at the input is monitored within the minimum signal time. If a further edge is detected at the input during the minimum signal time, this is interpreted as a renewed actuation and the minimum signal time starts if necessary. If the input signal has not changed during the minimum signal time an edge is detected and a telegram is sent on the bus if necessary.

The following example illustrates this:

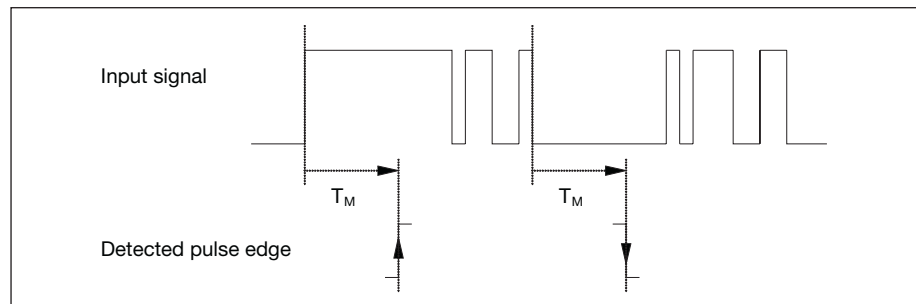

Fig. 52: Minimum signal time of the input signal on the edge to be recognised

Since only two pulse edges remain stable for the duration of the minimum signal time T_M, only these pulse edges are recognised as valid

Scan input after download, bus reset and bus voltage recovery

Options: yes/ no

Option yes = object value is scanned after download, bus reset and bus voltage recovery.

Option no = object value is not scanned after download, bus reset and bus voltage recovery.

If the option *yes* is selected in the parameter *Scan input after download, bus reset and bus voltage recovery* after download, the following parameter becomes visible.

Inactive wait state after bus voltage recovery**[0...30.000s, 0=inactive]**

Options: 0...30.000

This parameter is used to set the waiting time after bus voltage recovery. The state at the input terminals is detected after this time has timed out. The input reacts as if the state at the input terminals has just been set/not set.

Note: The inactive wait state does not add to the adjustable delay time for sending. It can be set in the “General” parameter window.

If the option *yes* is selected with the parameter *Activate minimum signal time*, the following parameters are visible.

After rising edge: baseOptions: 100ms/1s/10s/1 min/10min/1 h**Factor [1...255]**Options: 1...10...255**After falling edge: time base**Options: 100ms/1s/10s/1 min/10min/1 h**Factor [1...255]**Options: 1...10...255

The following parameters are visible in the parameter window “Channel A, general” if the option yes has been selected with the parameter *Distinction between short/long operation*.

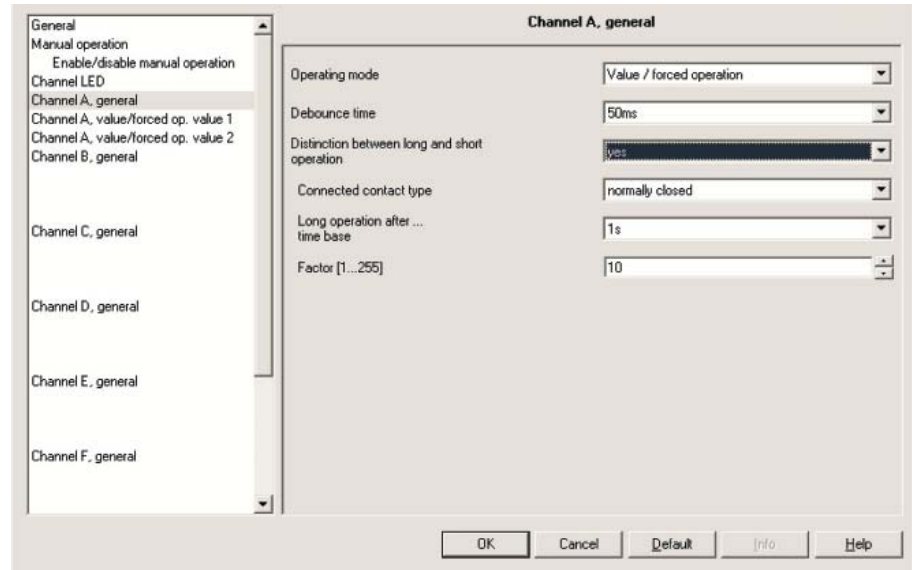

Fig. 53: Parameter window “Channel A, general” value/forced operation operating mode

Connected contact type

Options: normally open/
normally closed

Option *normally open* = input normally open when actuated

Option *normally closed* = input normally closed when actuated

Long operation after... time base

Options: 100ms/1s/10s/1 min/10min/1 h

Defines the period T_L after which an operation is interpreted as “long”.
($T_L = \text{time base} \times \text{factor}$)

Factor [1...255]

Options: 1...10...255

3.2.6.2 Parameter window “Channel A, value/ forced operation value X”

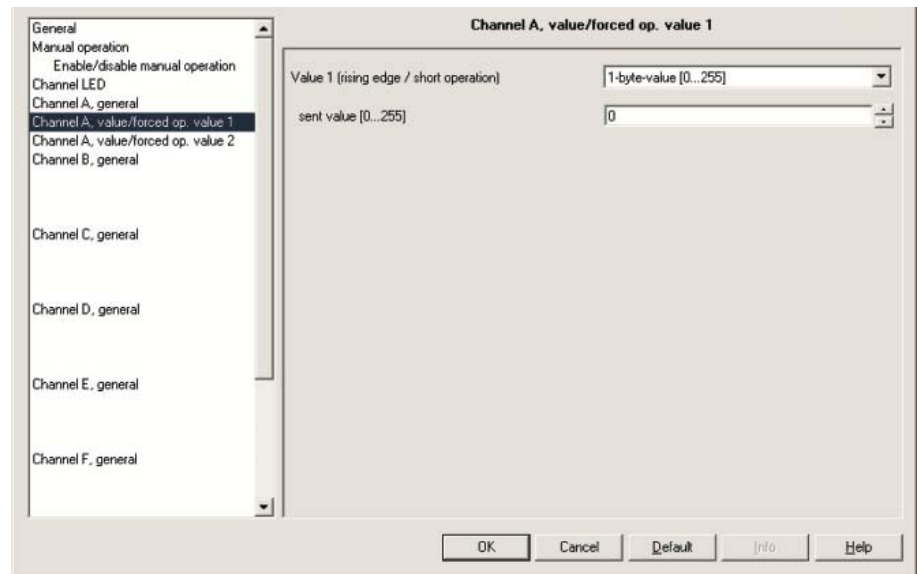

Fig. 54: Parameter window “Channel A, value/forced operation value 1” operating mode

Value X (with rising edge or with short operation)

- Options:
- no sending/
 - 1-Bit-values [0/1]/
 - 2-Bit-values (forced operation)/
 - 1-Byte-values [-128...127]/
 - 1-Byte-values [0...255]/
 - 1-Byte-values (8 bit scene)/
 - 2-Byte-values [-32.768...32.767]/
 - 2-Byte-values [0...65.535]/
 - 2-Byte-values [EIB floating point]/
 - 3-Byte-values [time]/
 - 4-Byte-values [-2.147.483.648...2.147.483.647]/
 - 4-Byte-values [0...4.294.967.295]

This parameter serves to define the data type which is sent when the contact is actuated.

Depending on the selection made for parameter value X (with rising edge or with short operation), different parameters appear. All parameters are described in the following.

sent value [X]

- Options:
- 0/1
 - 128...0...127
 - 0...255
 - 32.768...0...32.767
 - 0...65,535
 - 100.00...20.00...100.00
 - 2.147.483.648...0...2.147.483.647
 - 0...4.294.967.295

This parameter defines the value which is sent with the operation. The value range depends on the data type set for the value X.

sent value

Options: ON, activate forced position/
 OFF, activate forced operation/
Disable forced operation

This parameter defines the value which is sent with the operation.
 The forced operation function is explained in the following table:

Bit 1	Bit 0	Access	Description
0	0	Free	Switch object of the switch actuator is released by the Binary Input. The assigned sensor can control the switch actuator via the switch object. The Binary Input does not control the switch actuator. Bit "0" of the value of the priority object is not evaluated.
0	1	Free	The priority object sends a telegram with the group address of the priority object and the status of the switch object with every change of the state.
1	0	Off	Switch object of the switch actuator is blocked by the Binary Input. The assigned sensor can not control the switch actuator via the switch object. The Binary Input controls the switch actuator via the priority object. The switch actuator is switched off. Bit "0" of the value of the priority object is evaluated.
1	1	On	Switch object of the switch actuator is blocked by the Binary Input. The assigned sensor can not control the switch actuator via the switch object. The Binary Input controls the switch actuator via the priority object. The switch actuator is switched on.

Table 26: Operating mode value/forced operation priority object

8 bit scene

Options: Scene no.1...Scene no.64

This parameter defines the scene which is sent with the operation.

Store/recall scene

Options: recall/storing

This parameter defines if the scene is to be recalled or stored.

Hour [0...23]

Options: 0...23

Minute [0...59]

Options: 0...59

Second [0...59]

Options: 0...59

With these parameters the hours, minutes and seconds which should be sent during actuation are set.

3.2.6.3 Communication objects
“Channel A”

Number	Object Function	Name	Length	C	R	W	T	U
10	Blocking	Channel A, value/forced op.	1 bit	C	-	W	-	-
11	Value 1, unsigned	Channel A, value/forced op.	1 Byte	C	-	-	T	-
12	Value 2, unsigned	Channel A, value/forced op.	1 Byte	C	-	-	T	-

Fig. 55: Communication objects “Channel A” value/forced operation operating mode

No.	Function	Object name	Data type	Flags																																	
10	Block	Channel A, value/forced operation	EIS 1, 1 bit DPT 1.003	C, W																																	
<p>Telegram value “0” enable Channel A “1” block Channel A</p> <p>Via the “Block” communication object the channel connection can be blocked or released. A telegram is sent to the bus if a blocked channel is released. With activated “Blocked” communication object the inputs and the “manual operation” are blocked.</p> <p>Note: There is generally no reaction when a channel is blocked but</p> <ul style="list-style-type: none"> – with all operating modes waiting for a long button push or minimum signal duration is aborted – with the Switch/dimming sensor and Shutter sensor mode cyclic sending is interrupted – with the Control scene mode saving ends <p>during the blocking of a channel,</p> <ul style="list-style-type: none"> – a signal change on the terminals or with manual operation is ignored – communication objects are still updated and sent if necessary <p>If a channel is enabled a change of the signal states (compared to blocking) leads to immediate processing, e.g.</p> <ul style="list-style-type: none"> – start the minimum actuation or detection of a long/short button push – communication objects are sent if necessary 																																					
11	Value 1, X	Channel A, value/forced operation	EIS variable DPT variable	C, T																																	
<p>This communication object sends a value to the bus with short operation when opening or closing the contact. The value and data type can be freely set in the parameters.</p> <table border="0"> <tr> <td>1-Bit-values [0/1]</td> <td>EIS 1</td> <td>DPT 1.001 switch command</td> </tr> <tr> <td>2-Bit-values [0...3]</td> <td>EIS 8</td> <td>DPT 2.001 forced operation</td> </tr> <tr> <td>1-Byte-values [-128...127]</td> <td>EIS 14</td> <td>DPT 6.010 value</td> </tr> <tr> <td>1-Byte-values [0...255]</td> <td>EIS 6</td> <td>DPT 5.010 value</td> </tr> <tr> <td>1-Byte values 8 bit scene</td> <td>EIS 6</td> <td>DPT 18.001 brightness/ position value</td> </tr> <tr> <td>2-Byte-values [-32.768...32.767]</td> <td>EIS 10</td> <td>DPT 7.001 value</td> </tr> <tr> <td>2-Byte-values [0...65.535]</td> <td>EIS 10</td> <td>DPT 8.001 value</td> </tr> <tr> <td>2-Byte-values [EIB floating point]</td> <td>EIS 5</td> <td>DPT 9.001 temperature</td> </tr> <tr> <td>3-Byte-values [time]</td> <td>EIS 3</td> <td>DPT 10.001 time</td> </tr> <tr> <td>4-Byte-values [0...4.294.967.295]</td> <td>EIS 11</td> <td>DPT 12.001 value</td> </tr> <tr> <td>4-Byte-values [-2.147.483.648...2.147.483.647]</td> <td>EIS 11</td> <td>DPT 13.001 value</td> </tr> </table>					1-Bit-values [0/1]	EIS 1	DPT 1.001 switch command	2-Bit-values [0...3]	EIS 8	DPT 2.001 forced operation	1-Byte-values [-128...127]	EIS 14	DPT 6.010 value	1-Byte-values [0...255]	EIS 6	DPT 5.010 value	1-Byte values 8 bit scene	EIS 6	DPT 18.001 brightness/ position value	2-Byte-values [-32.768...32.767]	EIS 10	DPT 7.001 value	2-Byte-values [0...65.535]	EIS 10	DPT 8.001 value	2-Byte-values [EIB floating point]	EIS 5	DPT 9.001 temperature	3-Byte-values [time]	EIS 3	DPT 10.001 time	4-Byte-values [0...4.294.967.295]	EIS 11	DPT 12.001 value	4-Byte-values [-2.147.483.648...2.147.483.647]	EIS 11	DPT 13.001 value
1-Bit-values [0/1]	EIS 1	DPT 1.001 switch command																																			
2-Bit-values [0...3]	EIS 8	DPT 2.001 forced operation																																			
1-Byte-values [-128...127]	EIS 14	DPT 6.010 value																																			
1-Byte-values [0...255]	EIS 6	DPT 5.010 value																																			
1-Byte values 8 bit scene	EIS 6	DPT 18.001 brightness/ position value																																			
2-Byte-values [-32.768...32.767]	EIS 10	DPT 7.001 value																																			
2-Byte-values [0...65.535]	EIS 10	DPT 8.001 value																																			
2-Byte-values [EIB floating point]	EIS 5	DPT 9.001 temperature																																			
3-Byte-values [time]	EIS 3	DPT 10.001 time																																			
4-Byte-values [0...4.294.967.295]	EIS 11	DPT 12.001 value																																			
4-Byte-values [-2.147.483.648...2.147.483.647]	EIS 11	DPT 13.001 value																																			
12	See communication object 11																																				
13	not assigned																																				
... 19																																					

Table 27: Communication objects 10 to 19 “Channel A” value/forced operation operating mode

When there is a distinction between a short and long operation, 2 objects are visible per channel. One communication object only sends after a short operation while the other communication object only sends after a long operation.

Note: As standard the “Write” flag with the value objects (except for 1-bit objects) is deleted. Thus, the object value can not be modified via the bus. If this function is required, the “Write” flag must be set in the ETS. The object value is overwritten with the parameterised value on bus voltage recovery.

3.2.6.4 Communication objects “Channel B to H”

No.	Function	Object name	Data type	Flags
20 ... 29	Analogue 10...19 Channel A Value/forced operation	Channel B		
30 ... 39	Analogue 10...19 Channel A Value/forced operation	Channel C		
40 ... 49	Analogue 10...19 Channel A Value/forced operation	Channel D		
50 ... 59	Analogue 10...19 Channel A Value/forced operation	Channel E		
60 ... 69	Analogue 10...19 Channel A Value/forced operation	Channel F		
70 ... 79	Analogue 10...19 Channel A Value/forced operation	Channel G		
80 ... 89	Analogue 10...19 Channel A Value/forced operation	Channel H		

Table 28: Communication objects 20 to 89 “Channel B to H” value/forced operation operating mode

3.2.7 Control scene operating mode

This operating mode enables the recall and saving of states of multiple operating mode actuator groups. An actuator group comprises several communication objects that are linked with the same group address. It can consist of e.g. switch actuators (1-bit values) or dimming actuators (1-byte values).

Note: The standard settings for the options are underlined, e.g. option: yes/no

Store scene

The scene is simply adapted by saving the current actuator values.

The communication object “Store scene indication” sends the value “1”. The values of the affected communication objects are scanned via the bus. The scene is only stored when all scans are answered. The communication object “Store scene indication” sends the value “0”.

3.2.7.1 Parameter window "Channel A, general"

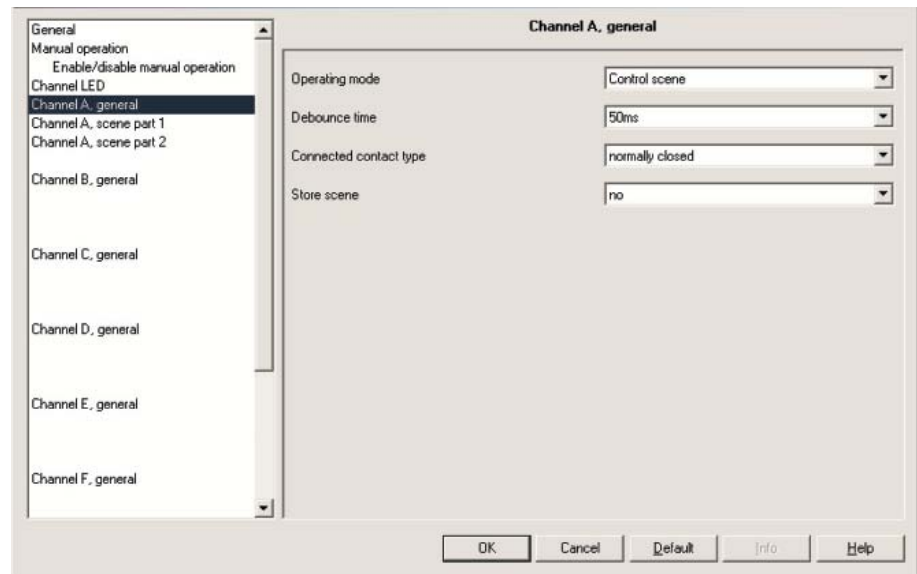

Fig. 56: Parameter window "Channel A, general" control scene operating mode

Debounce time

Options: 10ms/20ms/30ms/50ms/70ms/100ms/150ms

Debouncing prevents unwanted multiple operation of the input, e.g. due to bouncing of the contact.

What is debounce time?

If a pulse edge is detected at the input, the input reacts to it immediately (e.g. by sending a telegram). The debounce time T_D starts simultaneously. The signal at the input is not evaluated within the debounce period.

The following example illustrates this:

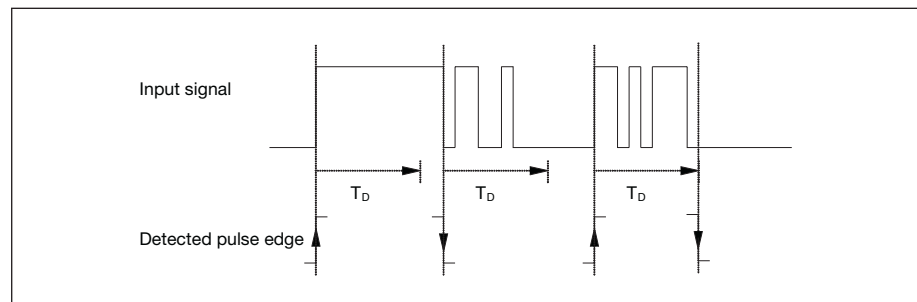

Fig. 57: Debounce time from input signal to detected edge

Once a pulse edge has been detected at the input, further edges are ignored for the duration of the debounce time T_D .

Connected contact type

Options: normally open/ normally closed

Option *normally open* = input normally open when actuated

Option *normally closed* = input normally closed when actuated

Store scene

Options: no/
on long operation/
object value = 1 /
on long operation and object value = 1

This parameter determines the manner in which storing of the current scene is initiated and which function the “Store scene” communication object has. This is dependent on the scene control.

Option *on long operation* =

The scene is stored as soon as an operation is detected and ends as soon as the button is released.

Option *object value = 1* =

If the “Store scene” communication object receives the value “1”, storing is activated. If the “Store scene” communication object receives the value “0”, storing is ended.

Option *on long operation and object value = 1* =

As soon as a long operation is detected and the “Enable storing” communication object has the value “1”, storing is activated. Storing is ended as soon as the “Enable storing” communication object has the value “0” or the button is released.

Note: If storing has not been successful when ending, the “Store scene indication” communication object sends the value “0”.

If the object *on long operation* and *on long operation and object value = 1* has been selected in the *Store scene* the following parameter appears.

Long operation after...

Options: 0.3s/0.4s/0.5s/0.6s/0.8s/1 s/1.2s/1.5s/2s/3s/4s/
5s/6s/7s/8s/9s/10s

Defines the period T_L after which an operation is interpreted as “long”.

3.2.7.2 Parameter window “Channel A, scene part X”

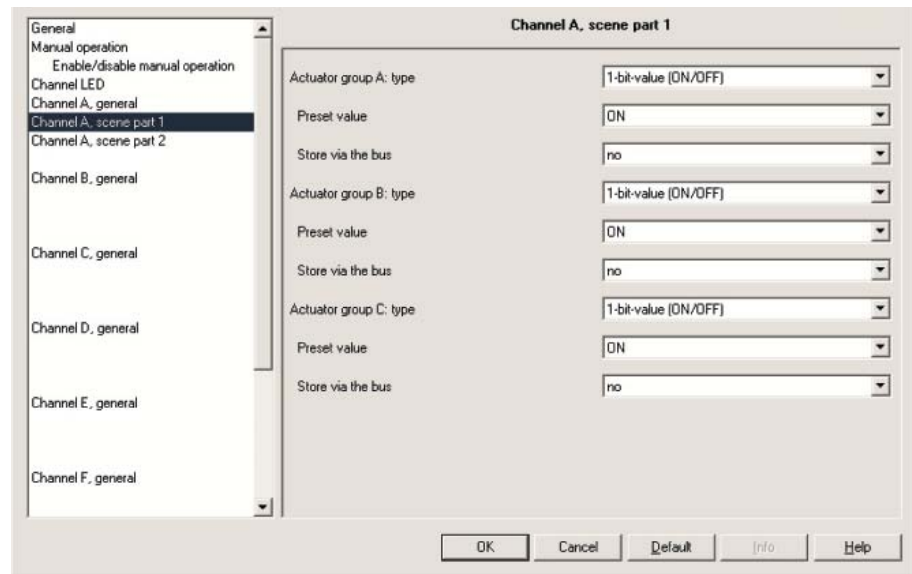

Fig. 58: Parameter window “Channel A, scene part 1” operating mode

Actuator group X: type

Options: 1-Bit-values [on/off]/
 1-Byte-values [0...100 %]/
 1-Byte-values [0...255]/
 2-Byte-values [temperature]

Various data types can be selected for each of the 6 actuator groups A...F. Depending on the value which has been selected for the actuator groups, various options are visible in the *preset value* parameters.

Preset value

Options: ON/OFF
 0 %/10 %/20 %/30 %/40 %/50 %/60 %/70 %/80 %/
 90 %/100 %
0...255
 -100.00...20.00...100.00

A value is preset for each actuator group A...F with these parameters.

Note: If a scene has been stored and the preset values are to be used after a download, the “Reset to preset value” communication object must be activated.

Store via the bus

Options: yes/no

This parameter sets if the scene is to be stored via the bus. If reading a communication object is not possible, the setting should remain set to *no* (see Store scene).

3.2.7.3 Communication objects
“Channel A”

Number	Object Function	Name	Length	C	R	W	T	U
10	Blocking	Channel A, scene control	1 bit	C	-	W	-	-
11	Actuator group A [on/off]	Channel A, scene control	1 bit	C	-	W	T	U
12	Actuator group B [on/off]	Channel A, scene control	1 bit	C	-	W	T	U
13	Actuator group C [on/off]	Channel A, scene control	1 bit	C	-	W	T	U
14	Actuator group D [on/off]	Channel A, scene control	1 bit	C	-	W	T	U
15	Actuator group E [on/off]	Channel A, scene control	1 bit	C	-	W	T	U
16	Actuator group F [on/off]	Channel A, scene control	1 bit	C	-	W	T	U
18	Store scene indication	Channel A, scene control	1 bit	C	-	-	T	-
19	Restore scene to default	Channel A, scene control	1 bit	C	-	W	-	-

Fig. 59: Communication objects “Channel A” scene control operating mode

No.	Function	Object name	Data type	Flags																
10	Block	Channel A, scene control	EIS 1, 1 bit DPT 1.003	C, W																
<p>Telegram value “0” enable Channel A “1” block Channel A</p> <p>Via the “Block” communication object the channel connection can be blocked or released. A telegram is sent to the bus if a blocked channel is released. With activated “Blocked” communication object the inputs and the “manual operation” are blocked.</p> <p>Note: There is generally no reaction when a channel is blocked but</p> <ul style="list-style-type: none"> – with all operating modes waiting for a long button push or minimum signal duration is aborted – with the Switch/dimming sensor and Shutter sensor mode cyclic sending is interrupted – with the Control scene mode saving ends <p>during the blocking of a channel,</p> <ul style="list-style-type: none"> – a signal change on the terminals or with manual operation is ignored – communication objects are still updated and sent if necessary <p>If a channel is enabled a change of the signal states (compared to blocking) leads to immediate processing, e.g.</p> <ul style="list-style-type: none"> – start the minimum actuation or detection of a long/short button push – communication objects are sent if necessary 																				
11	Actuator group A [variable]	Channel A, scene control	EIS variable DPT variable	C, W, T																
<p>This communication object sends the following values to the bus to suit the setting of the scene.</p> <table border="0"> <tr> <td>1-Bit-values [ON/OFF]</td> <td>EIS 1</td> <td>DPT 1.001</td> <td>switch command</td> </tr> <tr> <td>1-Byte-values [0...100]</td> <td>EIS 6</td> <td>DPT 5.001</td> <td>percentage value</td> </tr> <tr> <td>1-Byte-values [0...255]</td> <td>EIS 6</td> <td>DPT 5.010</td> <td>counter value</td> </tr> <tr> <td>2-Byte-values [temperature]</td> <td>EIS 5</td> <td>PT 9.001</td> <td>temperature</td> </tr> </table>					1-Bit-values [ON/OFF]	EIS 1	DPT 1.001	switch command	1-Byte-values [0...100]	EIS 6	DPT 5.001	percentage value	1-Byte-values [0...255]	EIS 6	DPT 5.010	counter value	2-Byte-values [temperature]	EIS 5	PT 9.001	temperature
1-Bit-values [ON/OFF]	EIS 1	DPT 1.001	switch command																	
1-Byte-values [0...100]	EIS 6	DPT 5.001	percentage value																	
1-Byte-values [0...255]	EIS 6	DPT 5.010	counter value																	
2-Byte-values [temperature]	EIS 5	PT 9.001	temperature																	
12	Actuator group B [variable]	Channel A, scene control	EIS variable DPT variable	C, W, T																
<p>This communication object sends the following values to the bus to suit the setting of the scene.</p> <table border="0"> <tr> <td>1-Bit-values [ON/OFF]</td> <td>EIS 1</td> <td>DPT 1.001</td> <td>switch command</td> </tr> <tr> <td>1-Byte-values [0...100]</td> <td>EIS 6</td> <td>DPT 5.001</td> <td>percentage value</td> </tr> <tr> <td>1-Byte-values [0...255]</td> <td>EIS 6</td> <td>DPT 5.010</td> <td>counter value</td> </tr> <tr> <td>2-Byte-values [temperature]</td> <td>EIS 5</td> <td>PT 9.001</td> <td>temperature</td> </tr> </table>					1-Bit-values [ON/OFF]	EIS 1	DPT 1.001	switch command	1-Byte-values [0...100]	EIS 6	DPT 5.001	percentage value	1-Byte-values [0...255]	EIS 6	DPT 5.010	counter value	2-Byte-values [temperature]	EIS 5	PT 9.001	temperature
1-Bit-values [ON/OFF]	EIS 1	DPT 1.001	switch command																	
1-Byte-values [0...100]	EIS 6	DPT 5.001	percentage value																	
1-Byte-values [0...255]	EIS 6	DPT 5.010	counter value																	
2-Byte-values [temperature]	EIS 5	PT 9.001	temperature																	
13	Actuator group C [variable]	Channel A, scene control	EIS variable DPT variable	C, W, T																
<p>This communication object sends the following values to the bus to suit the setting of the scene.</p> <table border="0"> <tr> <td>1-Bit-values [ON/OFF]</td> <td>EIS 1</td> <td>DPT 1.001</td> <td>switch command</td> </tr> <tr> <td>1-Byte-values [0...100]</td> <td>EIS 6</td> <td>DPT 5.001</td> <td>percentage value</td> </tr> <tr> <td>1-Byte-values [0...255]</td> <td>EIS 6</td> <td>DPT 5.010</td> <td>counter value</td> </tr> <tr> <td>2-Byte-values [temperature]</td> <td>EIS 5</td> <td>PT 9.001</td> <td>temperature</td> </tr> </table>					1-Bit-values [ON/OFF]	EIS 1	DPT 1.001	switch command	1-Byte-values [0...100]	EIS 6	DPT 5.001	percentage value	1-Byte-values [0...255]	EIS 6	DPT 5.010	counter value	2-Byte-values [temperature]	EIS 5	PT 9.001	temperature
1-Bit-values [ON/OFF]	EIS 1	DPT 1.001	switch command																	
1-Byte-values [0...100]	EIS 6	DPT 5.001	percentage value																	
1-Byte-values [0...255]	EIS 6	DPT 5.010	counter value																	
2-Byte-values [temperature]	EIS 5	PT 9.001	temperature																	

Table 27: Communication objects 10 to 13 “Channel A” scene control operating mode

No.	Function	Object name	Data type	Flags
14	Actuator group D [variable]	Channel A, scene control	EIS variable DPT variable	C, W, T
This communication object sends the following values to the bus to suit the setting of the scene.				
1-Bit-values [ON/OFF]		EIS 1	DPT 1.001 switch command	
1-Byte-values [0...100]		EIS 6	DPT 5.001 percentage value	
1-Byte-values [0...255]		EIS 6	DPT 5.010 counter value	
2-Byte-values [temperature]		EIS 5	PT 9.001 temperature	
15	Actuator group E [variable]	Channel A, scene control	EIS variable DPT variable	C, W, T
This communication object sends the following values to the bus to suit the setting of the scene.				
1-Bit-values [ON/OFF]		EIS 1	DPT 1.001 switch command	
1-Byte-values [0...100]		EIS 6	DPT 5.001 percentage value	
1-Byte-values [0...255]		EIS 6	DPT 5.010 counter value	
2-Byte-values [temperature]		EIS 5	PT 9.001 temperature	
16	Actuator group F [variable]	Channel A, scene control	EIS variable DPT variable	C, W, T
This communication object sends the following values to the bus to suit the setting of the scene.				
1-Bit-values [ON/OFF]		EIS 1	DPT 1.001 switch command	
1-Byte-values [0...100]		EIS 6	DPT 5.001 percentage value	
1-Byte-values [0...255]		EIS 6	DPT 5.010 counter value	
2-Byte-values [temperature]		EIS 5	PT 9.001 temperature	
17	Store scene	Channel A, scene control	EIS 1, 1bit DPT 1.003	C, W
This communication object only appears with the option “object value = 1”. This option can be set in the “Store scene” parameter. This communication object is used to initiate storing of the scene via the bus. The function depends on the type of scene storing.				
17	Enable storing	Channel A, scene control	EIS 1, 1bit DPT 1.003	C, W
This communication object only appears with the option “on long operation and object value = 1”. This option can be set in the “Store scene” parameter. This communication object is used to initiate storing of the scene via the bus. The function depends on the type of storing of the scene.				
18	Store scene indication	Channel A, scene control	EIS 1, 1bit DPT 1.003	C, T
This communication object is used to indicate the storing of a sceney e.g. on a LED. The function depends on the type of storing of the scene.				
19	Restore scene to default	Channel A, scene control	EIS 1, 1bit DPT 1.003	C, R, W, T
This communication object is used to reset the scene to the default setting.				

Table 30: Communication objects 14 to 19 “Channel A” scene control operating mode

3.2.7.4 Communication objects
"Channel B to H"

No.	Function	Object name	Data type	Flags
20 ... 29	Analogue 10...19 Channel A Control scene	Channel B		
30 ... 39	Analogue 10...19 Channel A Control scene	Channel C		
40 ... 49	Analogue 10...19 Channel A Control scene	Channel D		
50 ... 59	Analogue 10...19 Channel A Control scene	Channel E		
60 ... 69	Analogue 10...19 Channel A Control scene	Channel F		
70 ... 79	Analogue 10...19 Channel A Control scene	Channel G		
80 ... 89	Analogue 10...19 Channel A Control scene	Channel H		

Table 31: Communication objects 20 to 89 "Channel B to H" control scene operating mode

3.2.8 Switching sequence mode

The “Switching sequence” function enables up to five switch objects to be modified in a defined sequence by actuation of just a single input. Thus, up to to five actuators or actuator groups can be switched in a defined sequence.

Note: The standard settings for the options are underlined, e.g. option: yes/no

3.2.8.1 Parameter window “Channel A, general”

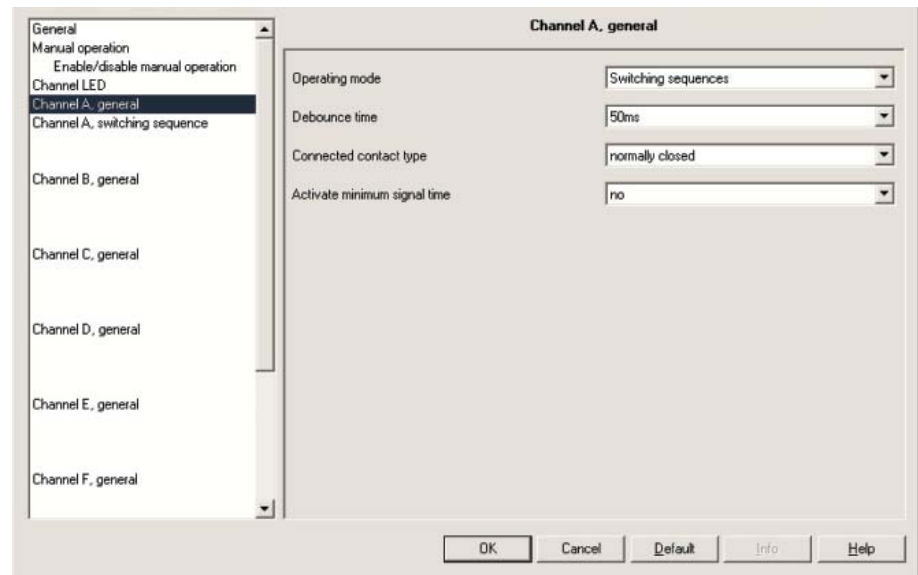

Fig. 60: Parameter window “Channel A, general” switching sequence operating mode

Debounce time

Options: 10ms/20ms/30ms/50ms/70ms/100ms/150ms

Debouncing prevents unwanted multiple operation of the input, e.g. due to bouncing of the contact.

What is debounce time?

If a pulse edge is detected at the input, the input reacts to it immediately (e.g. by sending a telegram). The debounce time T_D starts simultaneously. The signal at the input is not evaluated within the debounce period.

The following example illustrates this:

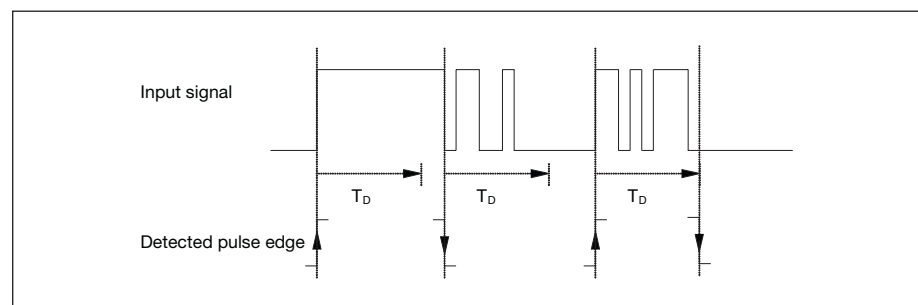

Fig. 61: Debounce time of the input signal on the edge to be recognised

Once a pulse edge has been detected at the input, further edges are ignored for the duration of the debounce time T_D .

Connected contact type

Options: normally open/
normally closed

Option *normally open* = input normally open when actuated

Option *normally closed* = input normally closed when actuated

Activate minimum signal time

Options: yes/no

What is minimum signal time?

This function differs from the debounce time by the fact that the telegram is sent only after the minimum signal time has timed out.

The functions in detail:

If an edge is detected at the input, the minimum signal time commences. No telegram is sent on the bus during this time. The signal at the input is monitored within the minimum signal time. If a further edge is detected at the input during the minimum signal time, this is interpreted as a renewed actuation and the minimum signal time starts if necessary. If the input signal has not changed during the minimum signal time an edge is detected and a telegram is sent on the bus if necessary.

The following example illustrates this:

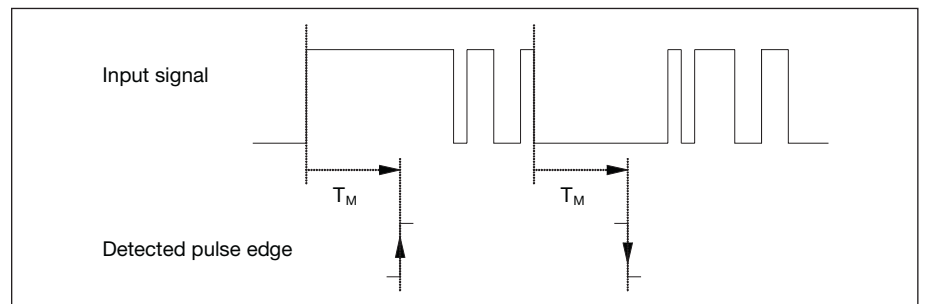

Fig. 62: Minimum signal time of the input signal on the edge to be recognised

Since only two pulse edges remain stable for the duration of the minimum signal time T_M, only these pulse edges are recognised as valid.

If the option *yes* is selected with the parameter *Activate minimum signal time*, the following parameters are visible.

Start of operation: time base

Options: 100ms/1s/10s/1 min/10min/1 h

Factor [1...255]

Options: 1...10...255

On end of operation: time base

Options: 100ms/1s/10s/1min/10min/1h

Factor [1...255]

Options: 1...10...255

3.2.8.2 Parameter window “Channel A, switching sequence”

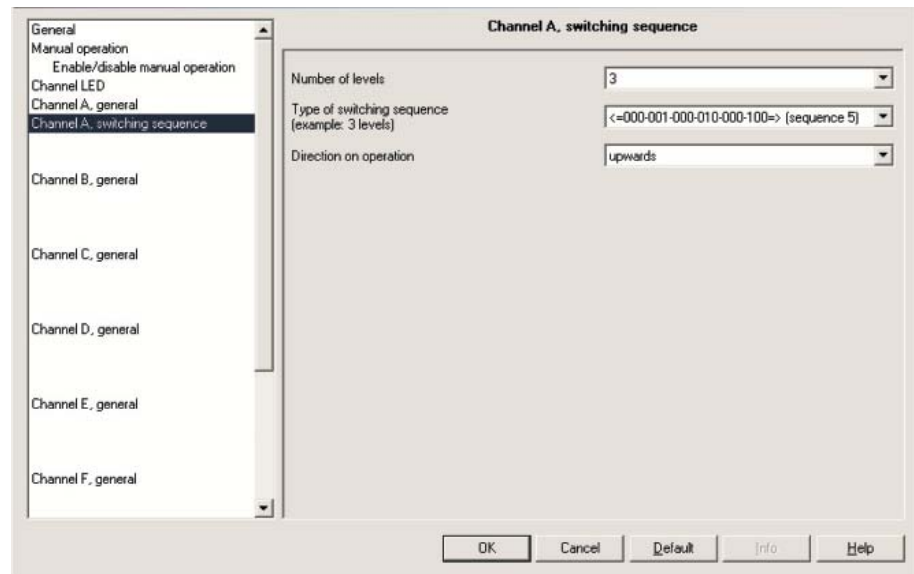

Fig. 63: Parameter window “Channel A, switching sequence” operating mode

Number of levels

Options: 2/3/4/5

The number of stages (max. 5) has the same meaning as the number of communication objects: The communication objects “Value 1” to “Value 5” are enabled accordingly.

Type of switching sequence with a 3 stage example

Options: =>000-001-011-111 (sequence 1)/
 Gray code (sequence 2)/
 <=000-001-011-111-011-001=> (sequence 3)/
 <=000-001-011-111-000=> (sequence 4)/
 <=000-001-000-010-000-100-000=> (sequence 5)/

The switching sequence relates to the states of the three communication objects (0 = OFF, 1 = ON).

The type of switching sequence can be selected here. Each sequence has different communication objects for each switching level.

The “Switching sequence” function enables up to five objects (1 bit) to be switched on or off in a defined sequence. The sequence is switched one level further after each operation.

Switching sequence 000-001-011-111 (sequence 1)

With this sequence a further communication object is switched on with each actuation. If all the communication objects are switched on, all further operations are ignored. At least two inputs are therefore required, one of which switches up a level and the other which switches down a level in the sequence.

Note: The communication objects of the inputs must have the same group address.

Switching sequence		Value of the communication objects		
Input operation number	Binary code	“Switch3”	“Switch2”	“Switch1”
0	000	OFF	OFF	OFF
1	001	OFF	OFF	ON
2	011	OFF	ON	ON
3	111	ON	ON	ON

Table 32: Switching sequence 1

Switching sequence Gray code (sequence 2)

This switching sequence runs through all the combinations of the communication objects in succession. Only the value of one communication object is changed between two switching levels. A clear application of this switching sequence is e.g. the switching of two groups of luminaries in the sequence 00 – 01 – 11 – 10 – 00 ...

You can find a ‘Gray code table’ in the appendix.

Switching sequence <=000-001-011-111-011-001=> (sequence 3)

With this sequence a further communication object is switched on each actuation. When all the communication objects are switched on, they are switched off again one after the other, starting with the last object that was switched on.

Switching sequence		Value of the communication objects		
Input operation number	Binary code	“Switch3”	“Switch2”	“Switch1”
0	000	OFF	OFF	OFF
1	001	OFF	OFF	ON
2	011	OFF	ON	ON
3	111	ON	ON	ON
4	011	OFF	ON	ON
5	001	OFF	OFF	ON
...				

Table 33: Switching sequence 3

Switching sequence <=000-001-011-111-000=> (sequence 4)

With this sequence a further communication object is switched on after each actuation. If all the communication objects are switched on, they are all switched off at once.

Switching sequence		Value of the communication objects		
Input operation number	Binary code	“Switch3”	“Switch2”	“Switch1”
0	000	OFF	OFF	OFF
1	001	OFF	OFF	ON
2	011	OFF	ON	ON
3	111	ON	ON	ON
...				

Table 34: Switching sequence 4

Switching sequence <=000-001-000-010-000-100-000=> (sequence 5)

This switching sequence switches a communication object on and then off again when operated. Thereafter, further communication objects are switched on or off.

Switching sequence		Value of the communication objects		
Input operation number	Binary code	“Switch3”	“Switch2”	“Switch1”
0	000	OFF	OFF	OFF
1	001	OFF	OFF	ON
2	000	OFF	OFF	OFF
3	010	OFF	ON	OFF
4	000	OFF	OFF	OFF
5	100	ON	OFF	OFF
...				

Table 35: Switching sequence 5

Further options

The switching level can be modified both via the operation of the input and via the communication object “Level increment/decrement”. This object is used for example to switch upwards or downwards with two or more inputs.

Note: The current switching level is always produced from the status of the communication objects. If e.g. a communication object is modified by another device, the current switching level can also be changed as a result.

Direction on operation

Options: upwards/downwards

With this parameter you can set a button to switch upwards or downwards.

3.2.8.3 Communication objects
“Channel A”

Number	Object Function	Name	Length	C	R	W	T	U
10	Blocking	Channel A, switching sequence	1 bit	C	-	W	-	-
11	Value 1	Channel A, switching sequence	1 bit	C	-	W	T	-
12	Value 2	Channel A, switching sequence	1 bit	C	-	W	T	-
13	Value 3	Channel A, switching sequence	1 bit	C	-	W	T	-
14	Value 4	Channel A, switching sequence	1 bit	C	-	W	T	-
15	Value 5	Channel A, switching sequence	1 bit	C	-	W	T	-
16	Level increment/decrement	Channel A, switching sequence	1 bit	C	-	W	-	-
17	Number of operation	Channel A, switching sequence	1 Byte	C	-	W	T	-

Fig. 64: Communication object “Channel A” switching sequence operating mode

No.	Function	Object name	Data type	Flags
10	Block	Channel A, switching sequence	EIS 1, 1 bit DTP 1.003	C, W
<p>Telegram value “0” Enable Channel A “1” Disable Channel A</p> <p>Via the “Block” communication object the channel connection can be blocked or released. A telegram is sent to the bus if a blocked channel is released. With activated “Blocked” communication object the inputs and the “manual operation” are blocked.</p> <p>Note: There is generally no reaction when a channel is blocked but</p> <ul style="list-style-type: none"> – with all operating modes waiting for a long button push or minimum signal duration is aborted – with the Switch/dimming sensor and Shutter sensor mode cyclic sending is interrupted – with the Control scene mode saving ends <p>during the blocking of a channel,</p> <ul style="list-style-type: none"> – a signal change on the terminals or with manual operation is ignored – communication objects are still updated and sent if necessary <p>With release of a channel the change leads to a change of the signal states (compared to before the block) to immediate processing, e.g.</p> <ul style="list-style-type: none"> – start the minimum actuation or detection of a long/short button push – communication objects are sent if necessary. 				
11	Value 1	Channel A, switching sequence	EIS1, 1 bit DTP 1.001	C, W, T
<p>The number of these maximum of 5 communication objects is set in the <i>number of switching sequences</i> parameter. The communication objects set the values within a switching sequence.</p>				
12	Value 2	Channel A, switching sequence	EIS1, 1 bit DTP 1.001	C, W, T
<p>The number of these maximum of 5 communication objects is set in the <i>number of switching sequences</i> parameter. The communication objects set the values within a switching sequence.</p>				
13	Value 3	Channel A, switching sequence	EIS1, 1 bit DTP 1.001	C, W, T
<p>The number of these maximum of 5 communication objects is set in the <i>number of switching sequences</i> parameter. The communication objects set the values within a switching sequence.</p>				
14	Value 4	Channel A, switching sequence	EIS1, 1 bit DTP 1.001	C, W, T
<p>The number of these maximum of 5 communication objects is set in the <i>number of switching sequences</i> parameter. The communication objects set the values within a switching sequence.</p>				
15	Value 5	Channel A, switching sequence	EIS1, 1 bit DTP 1.001	C, W, T
<p>The number of these maximum of 5 communication objects is set in the <i>number of switching sequences</i> parameter. The communication objects set the values within a switching sequence.</p>				

Table 36: Communication objects 10 to 15 “Channel A” switching sequence operating mode

No.	Function	Object name	Data type	Flags
16	Level increment/ decrement	Channel A, switching sequence	EIS 1, 1 bit DPT 1.001	C, W
Telegram value "0" decrement level "1" increment level If a "1" telegram is received on this communication object, the channel increments by one step in the switching sequence. If a "0" telegram is received it decrements by one step.				
17	Number of operation	Channel A, switching sequence	EIS 6,1 byte DPT 5.010	C, W, T
This communication object includes the number of operations of the respective switching sequence. With the synchronisation of multiple Binary Inputs the respective communication object must be linked with the same group address. Note: It is important to ensure that the number of communication objects in the synchronised inputs are equal (e.g. 3 stages).				
18 ... 19	not assigned			

Table 37: Communication objects 16 to 19 "Channel A" switching sequence operating mode

3.2.8.4 Communication objects "Channel B to H"

No.	Function	Object name	Data type	Flags
20 ... 29	Analogue 10...19 Channel A Switching sequence	Channel B		
30 ... 39	Analogue 10...19 Channel A Switching sequence	Channel C		
40 ... 49	Analogue 10...19 Channel A Switching sequence	Channel D		
50 ... 59	Analogue 10...19 Channel A Switching sequence	Channel E		
60 ... 69	Analogue 10...19 Channel A Switching sequence	Channel F		
70 ... 79	Analogue 10...19 Channel A Switching sequence	Channel G		
80 ... 89	Analogue 10...19 Channel A Switching sequence	Channel H		

Table 38: Communication objects 20 to 89 "Channel B to H" switching sequence operating mode

3.2.9 Operating mode multiple operation

If the input is operated on multiple occasions within a defined period, a defined object value can be modified by the number of operations. In this manner for example, different lightscenes are possible by multiple pushes of a button.

Note: The standard settings for the options are underlined, e.g. option: yes/no.

3.2.9.1 Parameter window “Channel A, general”

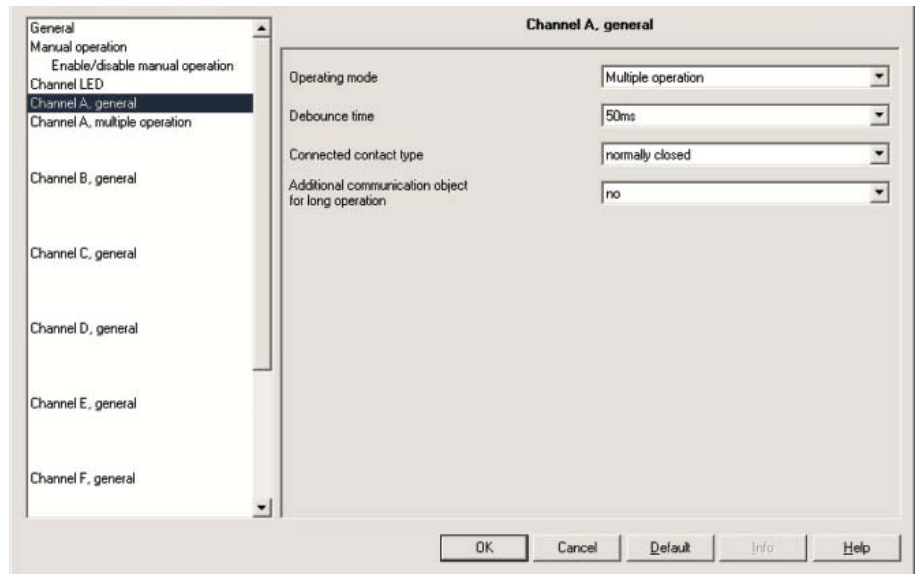

Fig. 65: Parameter window “Channel A, general” multiple operation operating mode

Debounce time

Options: 10ms/20ms/30ms/50ms/70ms/100ms/150ms

Debouncing prevents unwanted multiple operation of the input, e.g. due to bouncing of the contact.

What is debounce time?

If a pulse edge is detected at the input, the input reacts to it immediately (e.g. by sending a telegram). The debounce time T_D starts simultaneously. The signal at the input is not evaluated within the debounce period.

The following example illustrates this

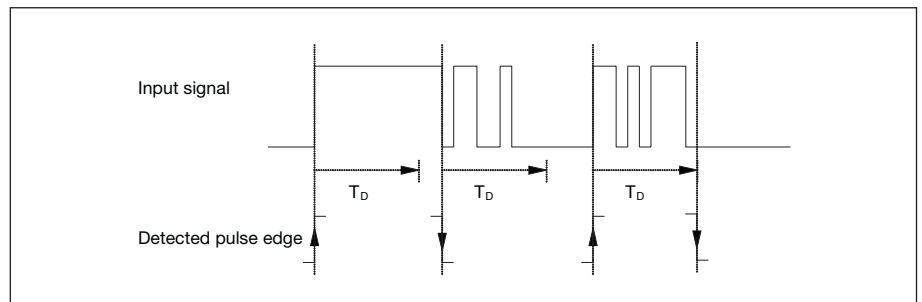

Fig. 66: Debounce time from input signal to detected edge

Once a pulse edge has been detected at the input, further edges are ignored for the duration of the debounce time T_D .

Connected contact typeOptions: normally open/normally closedOption *normally open* = input normally open when actuatedOption *normally closed* = input normally closed when actuated**Additional communication object for long operation**Options: yes/no

A further function is performed with longer operation of the input via the “Long operation” communication object. If one or more short operations are performed within the maximum time of a long operation, the short operations are ignored.

If the option *yes* is selected in the parameter *Additional communication object for long operation*, the following parameters are visible.

Long operation after...Options: 0.3s/0.4s/0.5s/0.6s/0.8s/1 s/1.2s/1.5s/2s/3s/4s/
5s/6s/7s/8s/9s/10s

Defines the period T_L after which an operation is interpreted as “long”.

3.2.9.2 Parameter window „Channel A, multiple operation”

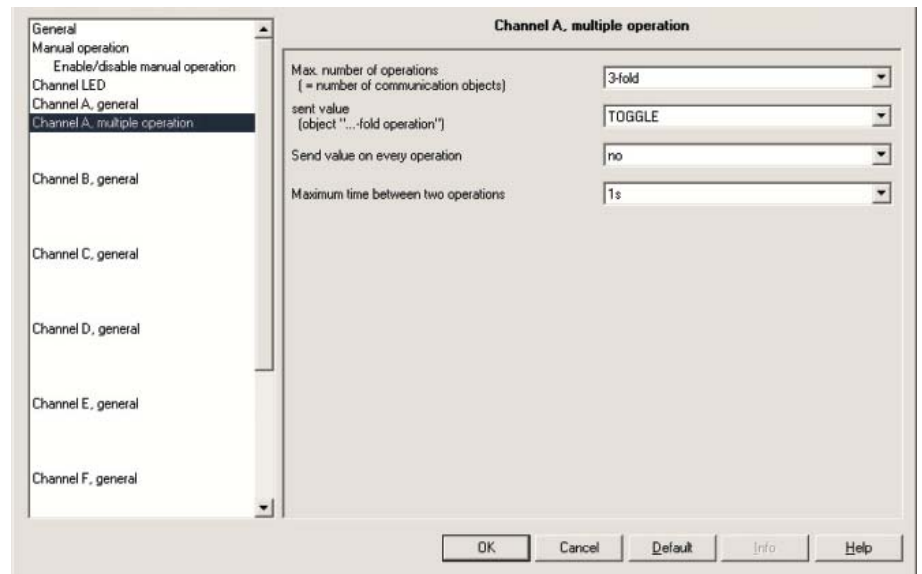

Fig. 67: Parameter window “Channel A, multiple operation” operating mode

Max. number of operations (= number of communication objects)

Options: single/
 2-fold/
 3-fold/
 4-fold

The maximum number of operations possible is set here. This number is equal to the “x-fold operation” of communication objects. If the actual number of operations is greater than the set maximum value, the input reacts as if the number of operations is equal to the maximum value set here.

sent value (object “...-fold operation”)

Options: ON/
 OFF/
 TOGGLE

This parameter sets which object value is to be sent. The settings *ON*, *OFF* and *TOGGLE* are possible. With *TOGGLE* the current object value is inverted.

Send value on every operation

Options: yes/no

Option yes = the respective object value is updated and sent with each operation.

Example With 3-fold operation the communication objects 1-fold operation (after the 1st operation), 2-fold operation (after the 2nd operation) and 3-fold operation (after the 3rd operation) are sent.

Maximum time between two operations

Options: 0.3s/0.4s/0.5s/0.6s/0.8s/1s/1.2s/1.5s/2s/3s/4s/
5s/6s/7s/8s/9s/10s

This parameter sets the maximum allowed interval between two operations. After operation the time entered here must time out. If no further operations occur within this time, the “Long operation” communication object is sent and the count is reinitiated with the next operation.

If the option yes is selected in the parameter Additional communication object for long operation, the following parameters appear.

sent value (communication object “Long operation”)

Options: ON/
OFF/
TOGGLE

A further function is performed with longer operation of the input via the “Long operation” communication object. If one or more short operations are performed within the maximum time of a long operation, the short operations are ignored.

3.2.9.3 Communication objects
“Channel A”

Number	Object Function	Name	Length	C	R	W	T	U
10	Blocking	Channel A, multiple operation	1 bit	C	-	W	-	-
11	1-fold operation	Channel A, multiple operation	1 bit	C	-	W	T	-
12	2-fold operation	Channel A, multiple operation	1 bit	C	-	W	T	-
13	3-fold operation	Channel A, multiple operation	1 bit	C	-	W	T	-
14	4-fold operation	Channel A, multiple operation	1 bit	C	-	W	T	-
15	Long operation	Channel A, multiple operation	1 bit	C	-	-	T	U

Fig. 68: Communication object “Channel A” multiple operation operating mode

No.	Function	Object name	Data type	Flags
10	Block	Channel A multiple operation	EIS1, 1 bit DTP 1.003	C, W
<p>Telegram value “0” Enable Channel A “1” Disable Channel A</p> <p>Via the “Block” communication object the channel connection can be blocked or released. A telegram is sent to the bus if a blocked channel is released. With activated “Blocked” communication object the inputs and the “manual operation” are blocked.</p> <p>Note: There is generally no reaction when a channel is blocked but</p> <ul style="list-style-type: none"> – with all operating modes waiting for a long button push or minimum signal duration is aborted – with the Switch/dimming sensor and Shutter sensor mode cyclic sending is interrupted – with the Control scene mode saving ends <p>during the blocking of a channel,</p> <ul style="list-style-type: none"> – a signal change on the terminals or with manual operation is ignored – communication objects continue to be updated and will be sent if necessary <p>With release of a channel the change leads to a change of the signal states (compared to before the block) to immediate processing, e.g.</p> <ul style="list-style-type: none"> – start the minimum actuation or detection of a long/short button push – communication objects are sent if necessary 				
11	1-fold operation	Channel A, multiple operation	EIS1, 1 bit DTP 1.001	C, W, T
<p>After multiple operations at an input the respective communication object is sent to suit the number of operations. The telegram value is adjustable in the parameters.</p>				
12	2-fold operation	Channel A, multiple operation	EIS1, 1 bit DTP 1.001	C, W, T
<p>After multiple operations at an input the respective communication object is sent to suit the number of operations. The telegram value is adjustable in the parameters.</p>				
13	3-fold operation	Channel A, multiple operation	EIS1, 1 bit DTP 1.001	C, W, T
<p>After multiple operations at an input the respective communication object is sent to suit the number of operations. The telegram value is adjustable in the parameters.</p>				
14	4-fold operation	Channel A, multiple operation	EIS1, 1 bit DTP 1.001	C, W, T
<p>After multiple operations at an input the respective communication object is sent to suit the number of operations. The telegram value is adjustable in the parameters.</p>				
15	Long operation	Channel A, multiple operation	EIS1, 1 bit DTP 1.001	C, W, T
<p>This communication object is only visible if the parameter “Additional communication object for long operation” value is set to yes. After a long operation has been detected, this communication object is sent. The time interval after which an operation is detected as “long” can be set.</p>				
16	not assigned			
...				
19				

Table 39: Communication objects 10 to 19 “Channel A” multiple operation operating mode

3.2.9.4 Communication objects
“Channel B to H”

No.	Function	Object name	Data type	Flags
20 ... 29	Analogue 10...19 Channel A, with multiple operation	Channel B		
30 ... 39	Analogue 10...19 Channel A, with multiple operation	Channel C		
40 ... 49	Analogue 10...19 Channel A, with multiple operation	Channel D		
50 ... 59	Analogue 10...19 Channel A, with multiple operation	Channel E		
60 ... 69	Analogue 10...19 Channel A, with multiple operation	Channel F		
70 ... 79	Analogue 10...19 Channel A, with multiple operation	Channel G		
80 ... 89	Analogue 10...19 Channel A, with multiple operation	Channel H		

Table 40: Communication objects 20 to 89 “Channel B to H” multiple operation operating mode

3.2.10 Counter operating mode The device can be used to count input pulse edges in the counter mode. In addition to a normal counter a differential counter can also be used if required. Both are operated via the counter pulses but count independently of each other.

Note: The standard settings for the options are underlined, e.g. option: yes/no.

3.2.10.1 Counting pulses

The pulse counting function is used to count input pulses.

The following diagram gives an overview:

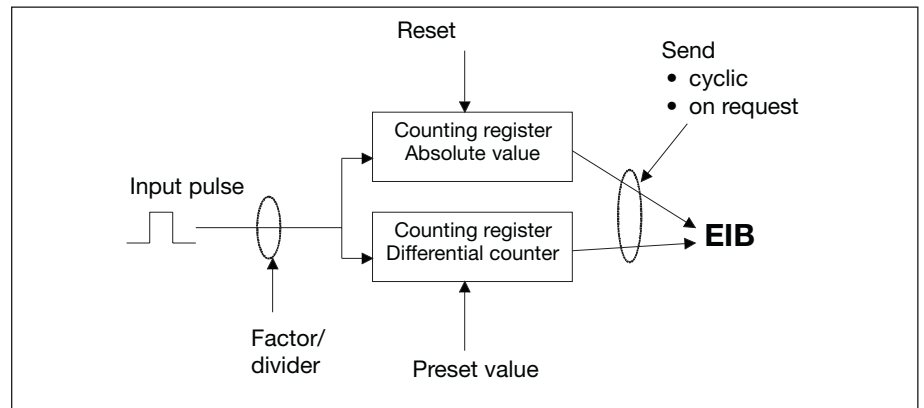

Fig. 69: Pulse counting function

In addition to the absolute counter, it is also possible to enable a differential counter which measures differential values (comparable to a daily mileage counter). The starting point of the differential counter can be selected at will.

To be able to adapt the count rate, the number of input pulses per count pulse can be set. Moreover, a counter state change can be set per count pulse. Both counter values can either be sent cyclically on the bus or on request.

An overrun value can be defined for the differential counter. A telegram is sent if an overrun occurs.

Note: The maximum counting frequency may not exceed 5Hz. The minimum pulse duration is 50ms. The max. capacitive load at the input is 22nF.

Note: The device can be connected to the S0 pulse outputs of electronic energy meters from type ABB only. The correct polarity must be observed.

3.2.10.2 Behaviour of the counter levels after a download

The counter levels are not erased after a download.

3.2.10.3 Behaviour of the counter levels after bus voltage failure

The counter levels are stored after a bus voltage failure.
The counter states can be sent after bus voltage recovery.

3.2.10.4 Peculiarities between the main counter and differential counter

Description	Main counter	Differential counter
Adjustable data type	yes	yes
Start value is the lower limit value, if counter is incremented	yes	yes
Start value is the upper limit value, if counter is decremented	yes	yes
The communication object "MC: limit value reached" sends a "1", as soon as the count pulse has exceeded the lower or upper limit value.	yes	yes
If "continue circular counting" is set, the counter is set to the start value and a possible overrun of the start value is simply added.	not adjustable	yes
If "stop until reset" is set, this and the following counter pulses are ignored until the differential counter is reset by the "DC: reset" communication object.	not adjustable	yes
Counter increments/decrements	adjustable	adjustable
Limit value 1 preset to zero	yes	adjustable
Circular counting	yes	adjustable
Reset of the counter	no	yes

Table 41: Peculiarities between the main counter and differential counter

3.2.10.5 Parameter window “Channel A, general”

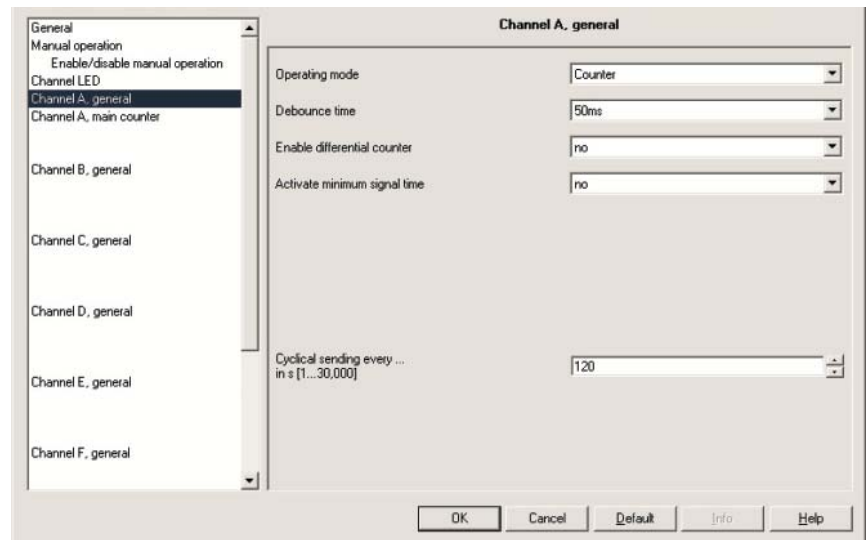

Fig. 70: Parameter window “Channel A, general” counter operating mode

Debounce time

Options: 10ms/20ms/30ms/50ms/70ms/100ms/150ms

Debouncing prevents unwanted multiple operation of the input, e.g. due to bouncing of the contact.

What is debounce time?

If a pulse edge is detected at the input, the input reacts to it immediately (e.g. by sending a telegram). The debounce time T_D starts simultaneously. The signal at the input is not evaluated within the debounce period.

The following example illustrates this:

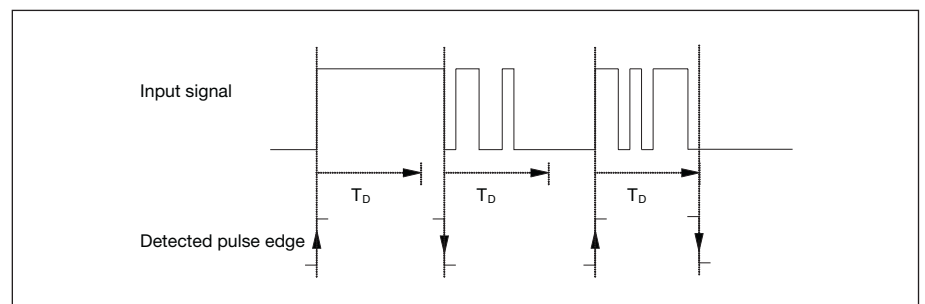

Fig. 71: Debounce time of the input signal on the edge to be recognised

Once a pulse edge has been detected at the input, further edges are ignored for the duration of the debounce time T_D .

Enable differential counter

Options: yes/no

If this parameter is set to “yes” the “differential counter” parameter window is also visible.

Activate minimum signal timeOptions: yes/no**What is minimum signal time?**

This function differs from the debounce time by the fact that the telegram is sent only after the minimum signal time has timed out.

The functions in detail:

If an edge is detected at the input, the minimum signal time commences. No telegram is sent on the bus during this time. The signal at the input is monitored within the minimum signal time. If a further edge is detected at the input during the minimum signal time, this is interpreted as a renewed actuation and the minimum signal time starts if necessary. If the input signal has not changed during the minimum signal time an edge is detected and a telegram is sent on the bus if necessary.

The following example illustrates this:

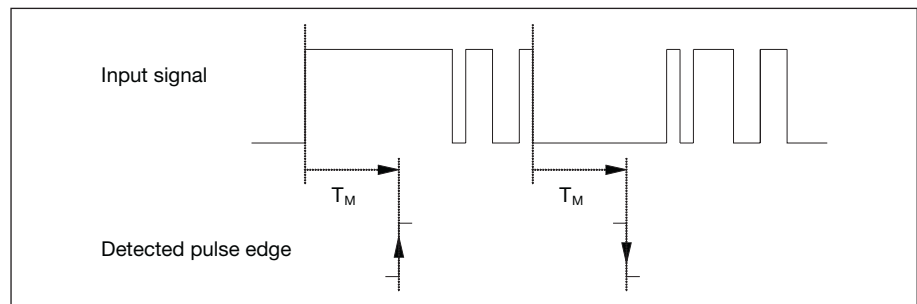

Fig. 72: Minimum signal time of the input signal on the edge to be recognised

Since only two pulse edges remain stable for the duration of the minimum signal time T_M, only these pulse edges are recognised as valid.

Cyclical sending every ...in s [1...30.000]Options: 1...120...30.000

This parameter is used to set the time for cyclical sending.

If the option *yes* is selected with the parameter *Activate minimum signal time*, the following parameters are visible.

After rising edge: time baseOptions: 100ms/1s/10s/1 min/10min/1 h**Factor [1...255]**Options: 1...10...255**After falling edge: time base**Options: 100ms/1s/10s/1 min/10min/1 h**Factor [1...255]**Options: 1...10...255

3.2.10.6 Parameter window “Channel A, main counter”

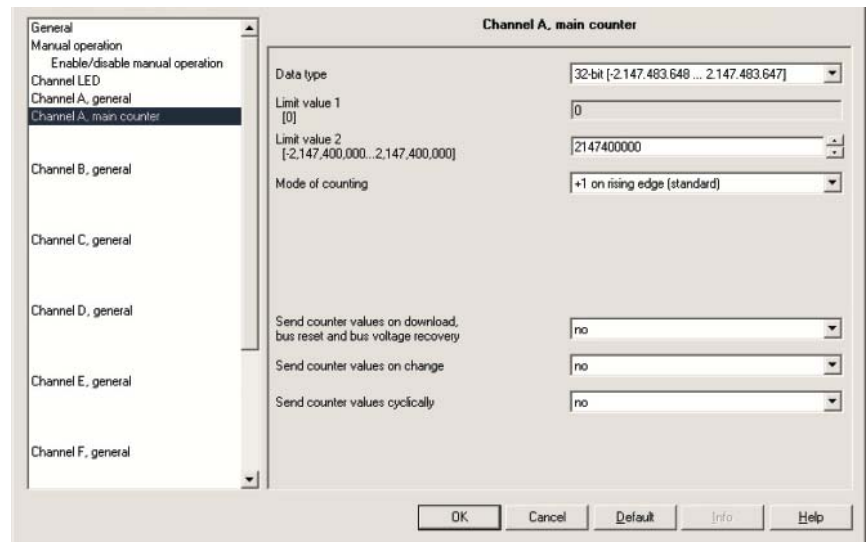

Fig. 73: Parameter window “Channel A, main counter” counter operating mode

Data type

Options: 8-bit [-128...127]/ 8-bit [0...255]/
16-bit [-32.768...32.767]/
16-bit [0...65.535]
32-bit [-2.147.485.648...2.147.483.647]

The data type of the counter is selected with this parameter.

Limit value 1 [0]

preset to 0

The limit value 1 is preset for every data type to 0

Limit value 2 [X]

Options:	<u>127</u>	[-128...127]
	<u>255</u>	[0...255]
	<u>32.767</u>	[-32.768...32.767]
	<u>65.565</u>	[0...65.535]
	<u>2.147.400.000</u>	[-2.147.400.000...2.147.400.000]

This parameter is dependent on the *Data type* parameter. Varying limit values are preset which depend on the *Data type* selected. This input field can be freely edited.

Note:

If the actual value falls below the lower limit value (only possible with a decrementing counter), the counter is set to the value of the higher limit value and the decrement pulse count is continued from this value = continuous circular counting.
If the preset or entered upper limit value is exceeded, the counter is set to zero and the pulse count is continued from zero (= lower limit value) = continuous circular counting.

Note: It is important to ensure that both limit values are set to different values. If identical end limit values are entered the behaviour of the counter cannot be defined.

The limit values can be set as required, i.e. Limit value 1 can be > or < Limit value 2. The application program automatically looks for the largest limit value from both set limits and commences to count up or down to suit the counting direction.

Mode of counting

Options: +1 on rising edge (standard)/
adapt ...

The mode of counting of the counter is set with this parameter.
+1 on rising edge (standard) = with a rising edge the counter value is incremented by one.

If the option *adapt...* has been selected with the *mode of counting* parameter, the following three parameters appear.

Create input pulse

Options: only on rising edge/
only on falling edge/
on both edges

This parameter sets how the input pulse is generated.

Option *only on rising edge* = the pulse is only generated with a rising edge

Option *only on falling edge* = the pulse is only generated with a falling edge

Option *on both edges* = the pulse is generated with a rising and a falling edge

Number of input pulses for one counter step [1...10.000]

Options: 1...10.000

This parameter sets the number of input pulses required to generate a counter pulse for the main and differential counter.

Example The counter states are incremented by 1 after 10 input pulses.

Change of counter for every counter step [-10.000...10.000]

Options: -10.000...1...10.000

This parameter is used to set the level of change on the counter state with each counter pulse.

Negative entry e.g. -1, defines a decrementing counter, e.g. 200...0

Positive entry e.g. 10, defines an incrementing counter, e.g. 10...200

Send counter values on download bus reset and bus voltage recovery

Options: yes/no

If “yes” is set here, the device sends the communication object “Counter value” on the bus after bus voltage recovery (after the send delay time has timed out).

Send counter values on change

Options: yes/no

This parameter is used to select if a change of the counter state is to be sent.

Send counter values cyclically

Options: yes/no

This parameter is used to determine if the counter values are to be sent cyclically on the bus.

3.2.10.7 Parameter window “Channel A, differential counter”

If the option *yes* is selected with the *Enable differential counter* parameter, the following parameters are visible.

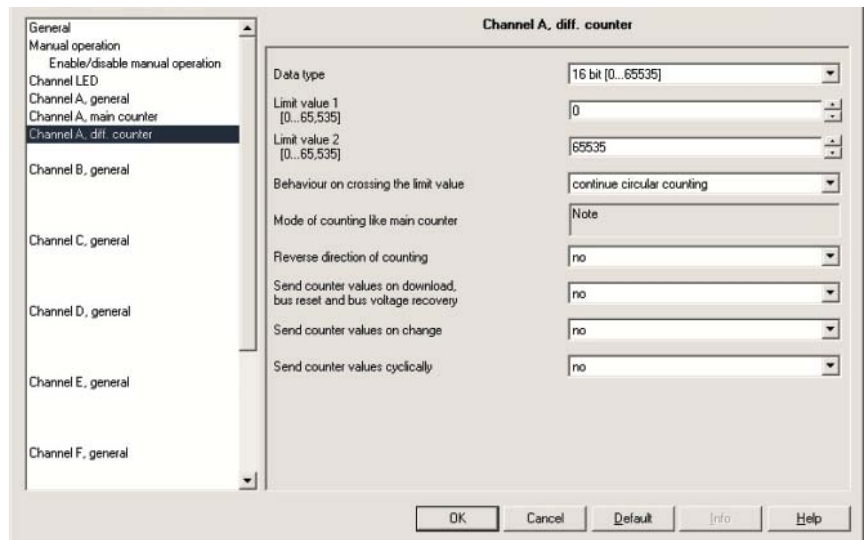

Fig. 74: Parameter window “Channel A, differential counter” counter operating mode

Data type

- Options: 8-bit [-128...127]/
 8-bit [0...255]/
 16-bit [-32.768...32.767]/
 16-bit [0...65.535]
32-bit [-2.147.485.648...2.147.483.647]

The data type of the differential counter is selected with this parameter.

Limit value 1 [X]

Options:	0	[-128...127]
	0	[0...255]
	0	[-32.768...32.767]
	0	[0...65.535]
	0	[-2.147.400.000...2.147.400.000]

Limit value 2 [X]

Options:	<u>127</u>	[-128...127]
	<u>255</u>	[0...255]
	<u>32.767</u>	[-32.768...32.767]
	<u>65.565</u>	[0...65.535]
	<u>2.147.400.000</u>	[-2.147.400.000...2.147.400.000]

This parameter is dependent on the *Data type* parameter; varying limit values are preset which depend on the *Data type* selected. This input field can be freely edited.

Note: If the actual value falls below the lower limit value (only possible with a decrementing counter), the differential counter is set to the value of the higher limit value and the decrement pulse count is continued from this value = continuous circular counting.

If the preset or entered upper limit value is exceeded, the differential counter is set to zero and the pulse count is continued from zero (= lower limit value) = continuous circular counting.

Note: It is important to ensure that both limit values are set to different values. If identical end limit values are entered the behaviour of the counter cannot be defined.

The limit values can be set as required, i.e. Limit value 1 can be > or < Limit value 2. The application program automatically looks for the largest limit value from both set limits and commences to count up or down to suit the counting direction.

Behaviour on crossing the limit value

Options: continue circular counting/
stop until reset

This parameter sets the reaction when a limit value is reached.
Option *continue circular counting* = counter continues circular counting
If the actual value falls below the lower limit value (only possible with a decrementing counter) the counter is set to the value of the higher limit value and the decrement pulse count is continued from this value.

If the value exceeds the upper limit value, the counter is set to the lower limit value and the pulse count is continued.

Option *stop until reset* = the counter stops and waits for a reset

Note: Continuous circular counting continues after a reset.

Mode of counting like main counter

This parameter serves as a note or remark. The direction of counting of the differential counter is identical to the main counter.

Reverse direction of counting

Options: yes/no

This parameter is used to reverse the direction of the count of the differential counter with respect to the main counter.

Send counter values on download bus reset and bus voltage recovery

Options: yes/no

If yes is set here, the device sends the “DC: counter value” communication object after bus voltage recovery (after the delay time for sending has timed out) to the bus.

Send counter values on change

Options: yes/no

This parameter is used to select if a change of the counter state is to be sent.

Send counter values cyclically

Options: yes/no

This parameter is used to determine if the counter values are to be sent cyclically on the bus.

3.2.10.8 Communication objects
**“Channel A,
 main counter”**

Number	Object Function	Name	Length	C	R	W	T	U
10	Blocking	Channel A, counter	1 bit	C	-	W	-	-
11	MC: counter value	Channel A, counter	4 Byte	C	-	-	T	-
13	Request counter value	Channel A, counter	1 bit	C	-	W	-	-
14	MC: limit value reached	Channel A, counter	1 bit	C	-	-	T	-

Fig. 75: Communication objects “Channel A, main counter” counter operating mode

No.	Function	Object name	Data type	Flags															
10	Block	Channel A, main counter	EIS 1, 1 bit DPT 1.003	C, W															
Telegram value “0” enable Channel A “1” block Channel A Via the “Block” communication object the channel connection can be blocked or released. A telegram is sent to the bus if a blocked channel is released. With activated “Blocked” communication object the inputs and the “manual operation” are blocked. Note: There is generally no reaction when a channel is blocked but <ul style="list-style-type: none"> - with all operating modes waiting for a long button push or minimum signal duration is aborted - with the Switch/dimming sensor and Shutter sensor mode cyclic sending is interrupted - with the Control scene mode saving ends during the blocking of a channel, <ul style="list-style-type: none"> - a signal change on the terminals or with manual operation is ignored - communication objects are still updated and sent if necessary If a channel is enabled a change of the signal states (compared to blocking) leads to immediate processing, e.g. <ul style="list-style-type: none"> - start the minimum actuation or detection of a long/short button push - communication objects are sent if necessary 																			
11	MC: Counter value	Channel A, main counter	EIS variable DPT variable	C, W, T															
The counter level of the main counter (MC) can be read via the communication object. <table border="0" style="width: 100%; border-collapse: collapse;"> <tr> <td style="width: 40%;">1-Byte-values [0...255]</td> <td style="width: 20%;">EIS 6</td> <td style="width: 40%;">DPT 5.010 counter value</td> </tr> <tr> <td>1-Byte-values [-128...+127]</td> <td>EIS 14</td> <td>DPT 6.010 counter value</td> </tr> <tr> <td>2-Byte-values [0...+65.535]</td> <td>EIS 10</td> <td>DPT 8.001 counter value</td> </tr> <tr> <td>2-Byte-values [-32.768...+32.767]</td> <td>EIS 10</td> <td>DPT 7.001 counter value</td> </tr> <tr> <td>4-Byte-values [-2.147.483.648...2.147.483.647]</td> <td>EIS 11</td> <td>DPT 13.001 counter value</td> </tr> </table>					1-Byte-values [0...255]	EIS 6	DPT 5.010 counter value	1-Byte-values [-128...+127]	EIS 14	DPT 6.010 counter value	2-Byte-values [0...+65.535]	EIS 10	DPT 8.001 counter value	2-Byte-values [-32.768...+32.767]	EIS 10	DPT 7.001 counter value	4-Byte-values [-2.147.483.648...2.147.483.647]	EIS 11	DPT 13.001 counter value
1-Byte-values [0...255]	EIS 6	DPT 5.010 counter value																	
1-Byte-values [-128...+127]	EIS 14	DPT 6.010 counter value																	
2-Byte-values [0...+65.535]	EIS 10	DPT 8.001 counter value																	
2-Byte-values [-32.768...+32.767]	EIS 10	DPT 7.001 counter value																	
4-Byte-values [-2.147.483.648...2.147.483.647]	EIS 11	DPT 13.001 counter value																	
12	not assigned																		
13	Request counter value	Channel A, main counter	EIS 1, 1 bit DPT 1.003	C, W															
Telegram value “0” do not request counter value “1” request counter value The counter value can be requested via the communication object																			
14	MC: Limit value exceeded	Channel A, main counter	EIS1, 1 bit DPT 1.002	C, T															
Telegram value “0” limit value not exceeded “1” limit value exceeded This communication object indicates if the limit value of the main counter (MC) has been exceeded.																			
15	not assigned																		
...																			
19																			

Table 42: Communication objects 13 to 19 “Channel A, main counter” counter operating mode

**3.2.10.9 Communication objects
“Channel B to H
main counter”**

No.	Function	Object name	Data type	Flags
20 ... 29	Analogue 10...19 Channel A Counter	Channel B		
30 ... 39	Analogue 10...19 Channel A Counter	Channel C		
40 ... 49	Analogue 10...19 Channel A Counter	Channel D		
50 ... 59	Analogue 10...19 Channel A Counter	Channel E		
60 ... 69	Analogue 10...19 Channel A Counter	Channel F		
70 ... 79	Analogue 10...19 Channel A Counter	Channel G		
80 ... 89	Analogue 10...19 Channel A Counter	Channel H		

Table 43: Communication objects 20 to 89 “Channel B to H main counter” counter operating mode

3.2.10.10 Communication objects
“Channel A main and
differential counter”

Number	Object Function	Name	Length	C	R	W	T	U
10	Blocking	Channel A, counter	1 bit	C	-	W	-	-
11	MC: counter value	Channel A, counter	4 Byte	C	-	-	T	-
12	DC: counter value	Channel A, counter	2 Byte	C	-	-	T	-
13	Request counter value	Channel A, counter	1 bit	C	-	W	-	-
14	MC: limit value exceeded	Channel A, counter	1 bit	C	-	-	T	-
15	DC: limit value exceeded	Channel A, counter	1 bit	C	-	-	T	-
16	DC: reverse direction	Channel A, counter	1 bit	C	-	W	-	-
17	DC: reset	Channel A, counter	1 bit	C	-	W	-	-
18	DC: stop	Channel A, counter	1 bit	C	-	W	-	-

Fig. 76: Communication objects “Channel A main and differential counter” counter operating mode

No.	Function	Object name	Data type	Flags															
10	Block	Channel A, main counter	EIS 1, 1 bit DPT 1.003	C, W															
<p>Telegram value “0” enabled Channel A “1” block Channel A</p> <p>Via the “Block” communication object the channel connection can be blocked or released. A telegram is sent to the bus if a blocked channel is released. With activated “Blocked” communication object the inputs and the “manual operation” are blocked.</p> <p>Note: There is generally no reaction when a channel is blocked but</p> <ul style="list-style-type: none"> - with all operating modes waiting for a long button push or minimum signal duration is aborted - with the Switch/dimming sensor and Shutter sensor mode cyclic sending is interrupted - with the Control scene mode saving ends <p>during the blocking of a channel,</p> <ul style="list-style-type: none"> - a signal change on the terminals or with manual operation is ignored - communication objects are still updated and sent if necessary <p>if a channel is enabled a change of the signal states (compared to blocking) leads to immediate processing, e.g.</p> <ul style="list-style-type: none"> - start the minimum actuation or detection of a long/short button push - communication objects are sent if necessary 																			
11	MC: counter value	Channel A, main counter	EIS variable DPT variable	C, W, T															
<p>The counter level of the main counter (MC) can be read via the communication object.</p> <table border="0"> <tr> <td>1-Byte-values [0...255]</td> <td>EIS 6</td> <td>DPT 5.010 counter value</td> </tr> <tr> <td>1-Byte-values [-128...+127]</td> <td>EIS 14</td> <td>DPT 6.010 counter value</td> </tr> <tr> <td>2-Byte-values [0...+65.535]</td> <td>EIS 10</td> <td>DPT 8.001 counter value</td> </tr> <tr> <td>2-Byte-values [-32.768...+32.767]</td> <td>EIS 10</td> <td>DPT 7.001 counter value</td> </tr> <tr> <td>4-Byte-values [-2.147.483.648...2.147.483.647]</td> <td>EIS 11</td> <td>DPT 13.001 counter value</td> </tr> </table>					1-Byte-values [0...255]	EIS 6	DPT 5.010 counter value	1-Byte-values [-128...+127]	EIS 14	DPT 6.010 counter value	2-Byte-values [0...+65.535]	EIS 10	DPT 8.001 counter value	2-Byte-values [-32.768...+32.767]	EIS 10	DPT 7.001 counter value	4-Byte-values [-2.147.483.648...2.147.483.647]	EIS 11	DPT 13.001 counter value
1-Byte-values [0...255]	EIS 6	DPT 5.010 counter value																	
1-Byte-values [-128...+127]	EIS 14	DPT 6.010 counter value																	
2-Byte-values [0...+65.535]	EIS 10	DPT 8.001 counter value																	
2-Byte-values [-32.768...+32.767]	EIS 10	DPT 7.001 counter value																	
4-Byte-values [-2.147.483.648...2.147.483.647]	EIS 11	DPT 13.001 counter value																	
12	DC: counter value	Channel A, main counter	EIS variable DPT variable	C, W, T															
<p>The counter level of the differential counter (DC) can be read via the communication object.</p> <table border="0"> <tr> <td>1-Byte-values [0...255]</td> <td>EIS 6</td> <td>DPT 5.010 counter value</td> </tr> <tr> <td>1-Byte-values [-128...+127]</td> <td>EIS 14</td> <td>DPT 6.010 counter value</td> </tr> <tr> <td>2-Byte-values [0...+65.535]</td> <td>EIS 10</td> <td>DPT 8.001 counter value</td> </tr> <tr> <td>2-Byte-values [-32.768...+32.767]</td> <td>EIS 10</td> <td>DPT 7.001 counter value</td> </tr> <tr> <td>4-Byte-values [-2.147.483.648...2.147.483.647]</td> <td>EIS 11</td> <td>DPT 13.001 counter value</td> </tr> </table>					1-Byte-values [0...255]	EIS 6	DPT 5.010 counter value	1-Byte-values [-128...+127]	EIS 14	DPT 6.010 counter value	2-Byte-values [0...+65.535]	EIS 10	DPT 8.001 counter value	2-Byte-values [-32.768...+32.767]	EIS 10	DPT 7.001 counter value	4-Byte-values [-2.147.483.648...2.147.483.647]	EIS 11	DPT 13.001 counter value
1-Byte-values [0...255]	EIS 6	DPT 5.010 counter value																	
1-Byte-values [-128...+127]	EIS 14	DPT 6.010 counter value																	
2-Byte-values [0...+65.535]	EIS 10	DPT 8.001 counter value																	
2-Byte-values [-32.768...+32.767]	EIS 10	DPT 7.001 counter value																	
4-Byte-values [-2.147.483.648...2.147.483.647]	EIS 11	DPT 13.001 counter value																	

Table 44: Communication objects 10 to 12 “Channel A main and differential counter” counter operating mode

No.	Function	Object name	Data type	Flags
13	Request counter value	Channel A, main counter	EIS1, 1 bit DTP 1.003	C, W
Telegram value "0" "1" Do not request counter value Request counter value The counter value can be requested via the communication object.				
14	MC: Limit value exceeded	Channel A, main counter	EIS1, 1 bit DTP 1.002	C, W
Telegram value "0" "1" limit value not exceeded limit value exceeded This communication object indicates if the limit value of the main counter (MC) has been exceeded.				
15	DC: Limit value exceeded	Channel A, main counter	EIS1, 1 bit DTP 1.002	C, T
Telegram value "0" "1" limit value not exceeded limit value exceeded This communication object indicates if the limit value of the differential (temporary) counter (DC) has been exceeded.				
16	DC: reverse direction	Channel A, main counter	EIS1, 1 bit DTP 1.002	C, R, W, T
Telegram value "0" "1" do not reverse direction of count reverse direction of count The counting direction of the differential counter (DC) can be read via the communication object.				
17	DC: reset	Channel A, main counter	EIS1, 1 bit DTP 1.002	C, R, W, T
Telegram value "0" "1" do not reset temporary (diff) counter reset temporary (diff) counter The differential counter (DC) can be reset to the start value via this communication object				
18	DC: stop	Channel A, main counter	EIS1, 1 bit DTP 1.002	C, R, W, T
Telegram value "0" "1" do not stop temporary (diff) counter stop temporary (diff) counter The differential counter (DC) can be stopped via this communication object.				
19	not assigned			

Table 45: Communication objects 13 to 19 "Channel A main and differential counter" counter operating mode

**3.2.10.11 Communication objects
“Channel B to H
main and differential
counter”**

No.	Function	Object name	Data type	Flags
20 ... 29	Analogue 10...19 Channel A Counter	Channel B		
30 ... 39	Analogue 10...19 Channel A Counter	Channel C		
40 ... 49	Analogue 10...19 Channel A Counter	Channel D		
50 ... 59	Analogue 10...19 Channel A Counter	Channel E		
60 ... 69	Analogue 10...19 Channel A Counter	Channel F		
70 ... 79	Analogue 10...19 Channel A Counter	Channel G		
80 ... 89	Analogue 10...19 Channel A Counter	Channel H		

Table 46: Communication objects 20 to 89 “Channel B to H main and differential counter” counter operating mode

4 Planing and application

In this section you will find some tips and application examples for practical use of the Binary Inputs.

4.1 Operation with central function (light switching)

1 button operation

The lighting is switched on or off with short operation of a button. A long operation switches off the lighting centrally.

Linking the group addresses:

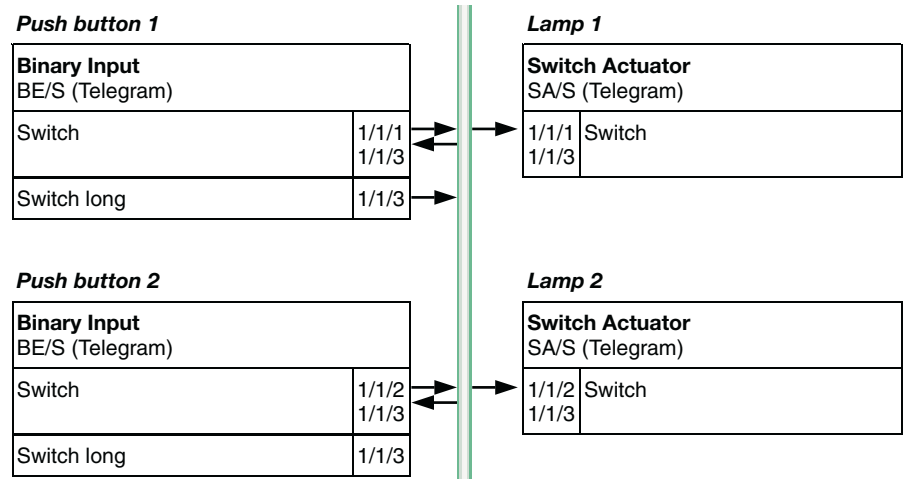

Fig. 77: 2 button operation with central function

Parameter settings for button 1 and button 2:

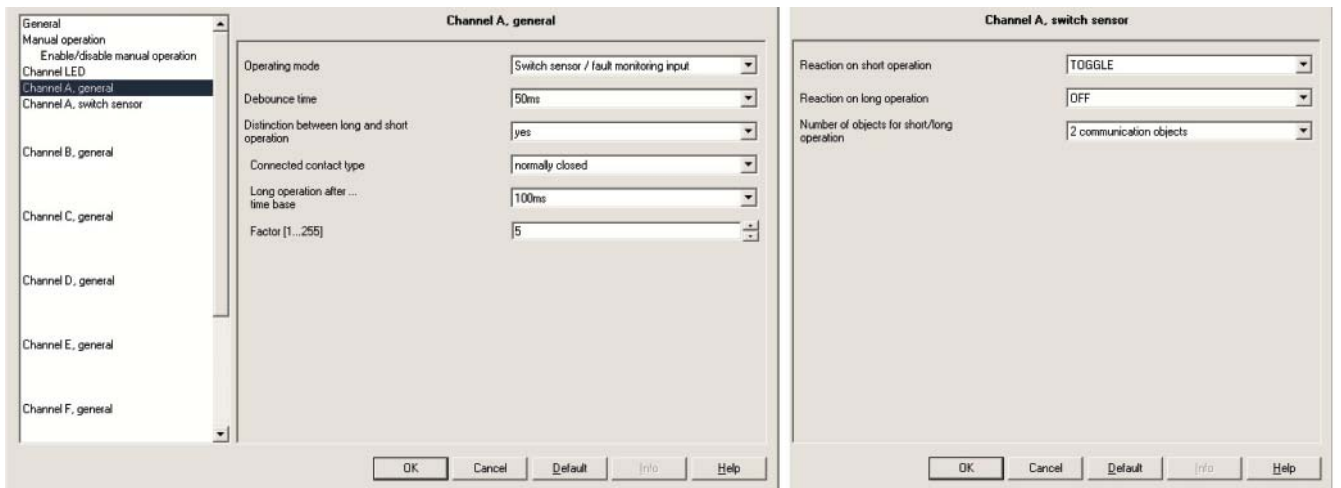

Fig. 78: 1 button operation with general function

4.2 Fault signal input

Two incoming circuit-breakers, a coupling switch and a generator switch have to be monitored in a switchgear system. The Binary Input should send a cyclical “In operation” telegram every 10 s. The interactive waiting time and the delay time for sending should be set to 17 s respectively. The manual operation should be released/blocked via a communication object. The switchover between both operating states should occur automatically after 300 s and via button operation. The individual manual operation buttons should be without function. The respective channel LEDs should not provide inverted representation. When the contacts are closed, an ON and OFF telegram should be sent every 30 s.

- Incoming circuit-breaker: minimum signal time 100 ms
- Coupling switch: minimum signal time 100 ms
- Generator switch: minimum signal time 100 ms

Parameter settings:

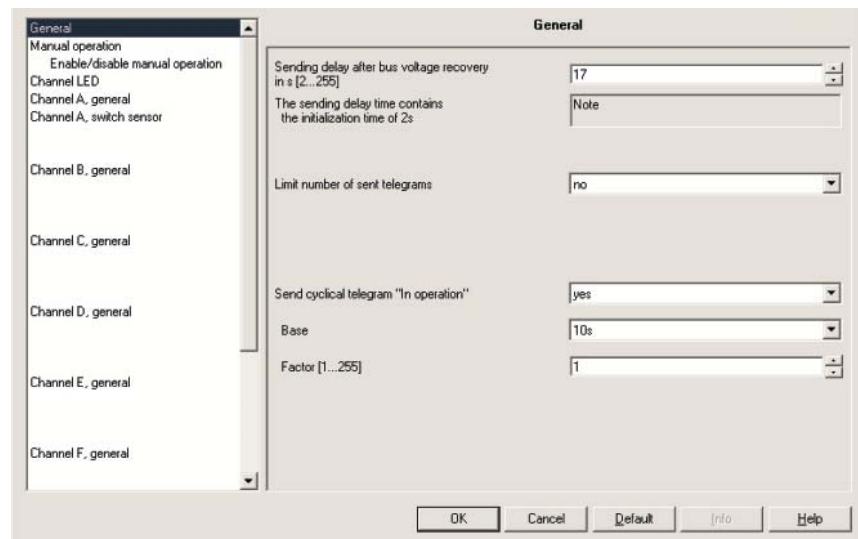

Fig. 79: Parameter window “General” fault signal input

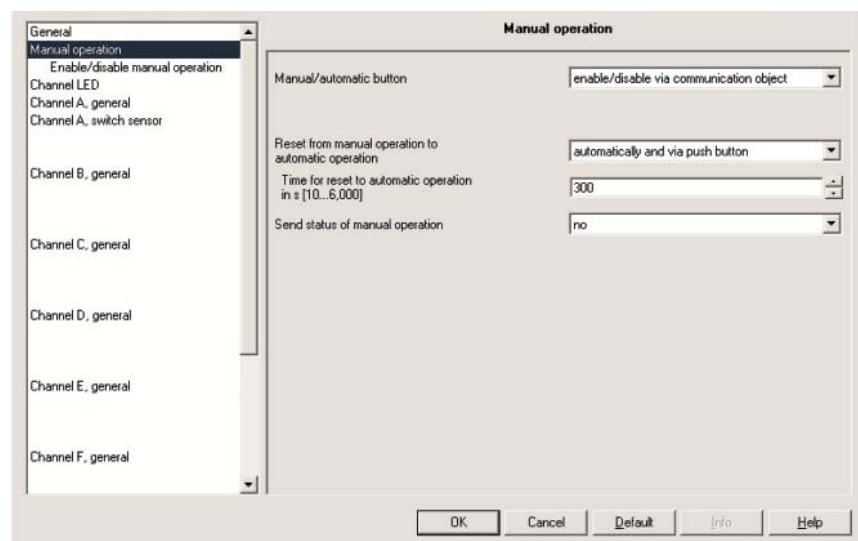

Fig. 80: Parameter window “Manual Operation” fault signal input

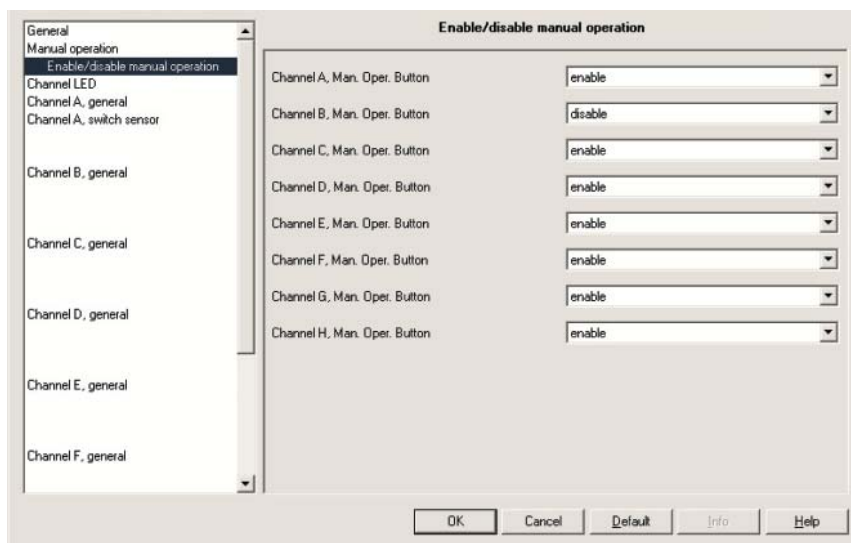

Fig. 81: Parameter window Fault signal input "Enable/release manual operation button"

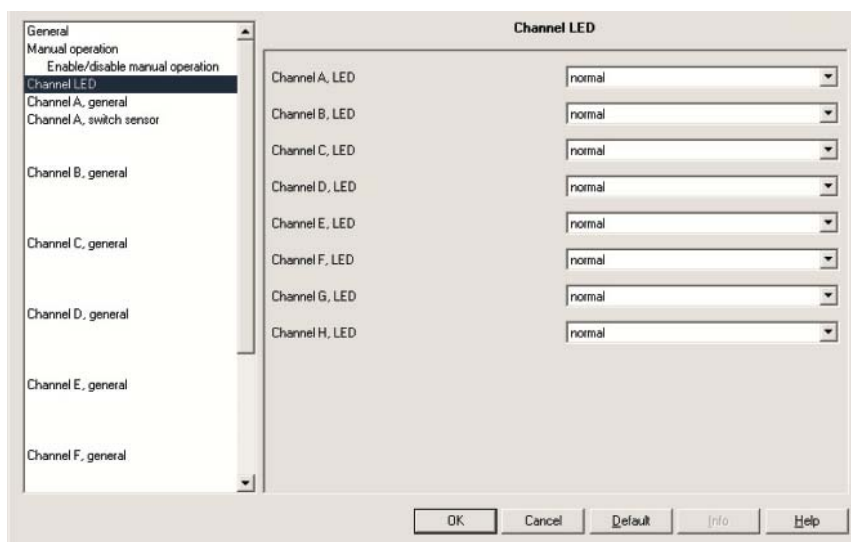

Fig. 82: Parameter window Fault signal input "Channel LED display"

Channel A parameter settings also apply for the Channels B, C and D.

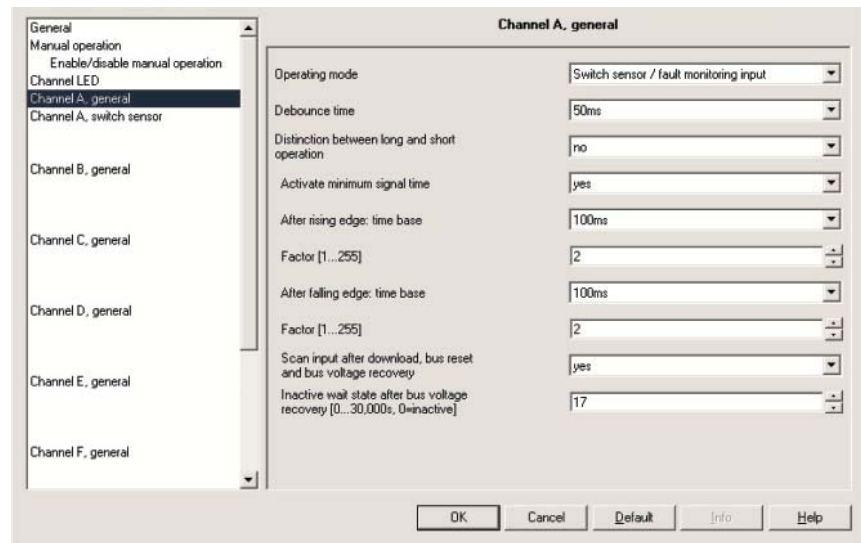

Fig. 83: Parameter window "Channel A, general" fault signal input

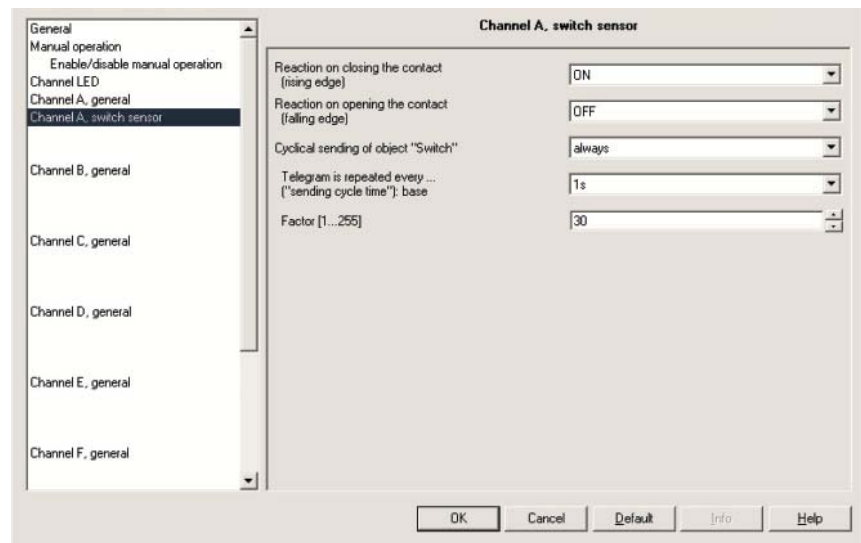

Fig. 84: Parameter window "Channel A, switch sensor" fault signal input

4.3 Operation of lighting (dim lighting)

1 button operation

Short operation switches the lighting on or off, a long operation alternately dims the lighting brighter or darker (opposite to the last dim process). Both buttons operate the same luminaries.

Linking the group addresses:

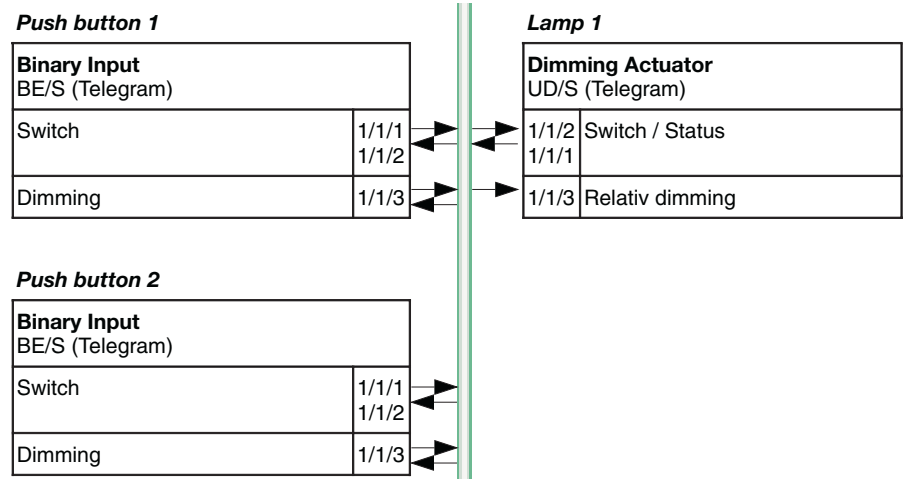

Fig. 85: 2 button operation of lighting (dim lighting)

Parameter settings for button 1 and button 2:



Fig. 86: 1 button operation of lighting (dim lighting)

2 button operation

The same group address link is also suitable for 2 button dimming. Modification of the parameters:

- “Reaction on short operation” = “ON” or “OFF“
- “Reaction on long operation” = “Dim BRIGHTER” or “Dim DARKER”

4.4 Operation of shutter

1 button operation

Button 1 and button 2 operate shutter 1 from different locations. With short operation the shutter moves (in the opposite direction to the last movement), a long operation adjusts the position of the lamella.

Linking the group addresses:

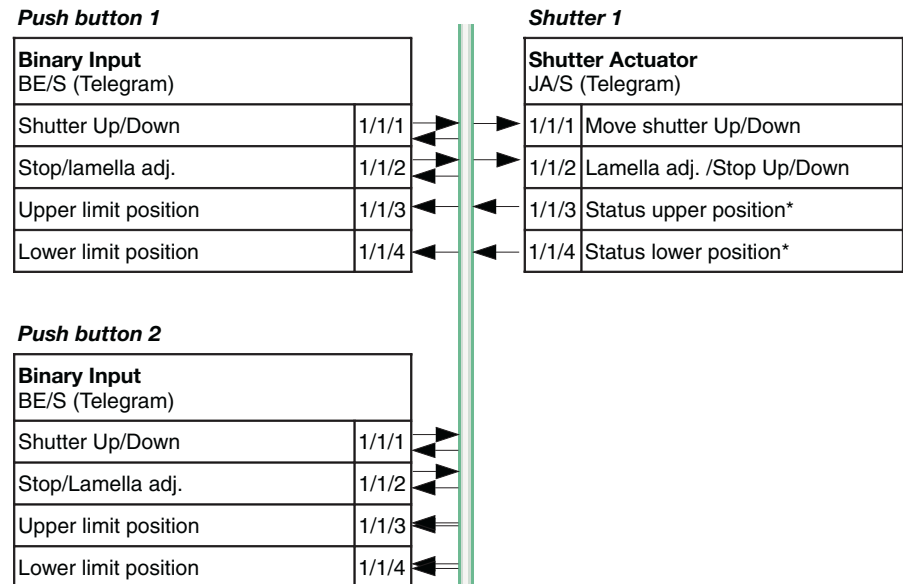

Fig. 87: 2 button operation of shutters

* The Binary Input receives feedback via the communication objects “Upper limit position” or “Lower limit position” indicating if the shutter actuator is in its end limit position. If this is not possible, 2 button operation is recommended.

Parameter settings for button 1 and button 2:

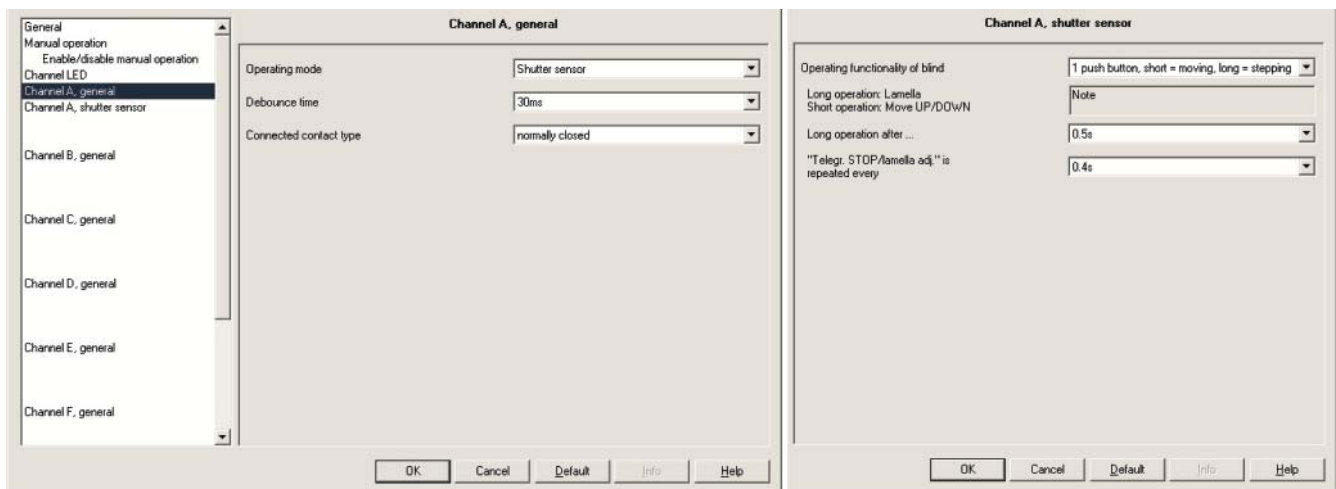

Fig. 88: 1 button operation of shutters

2 button operation

Button 1 and button 2 operate shutter 1 from a single location. With long operation the shutter moves down (button 1) or up (button 2). With short operation the lamella closes (button 1) or opens (button 2) by a step.

Linking the group addresses:



Abb. 89: 2-Taster-Bedienung von Jalousie Taster 1 und 2

Parameter settings for button 1 and button 2:

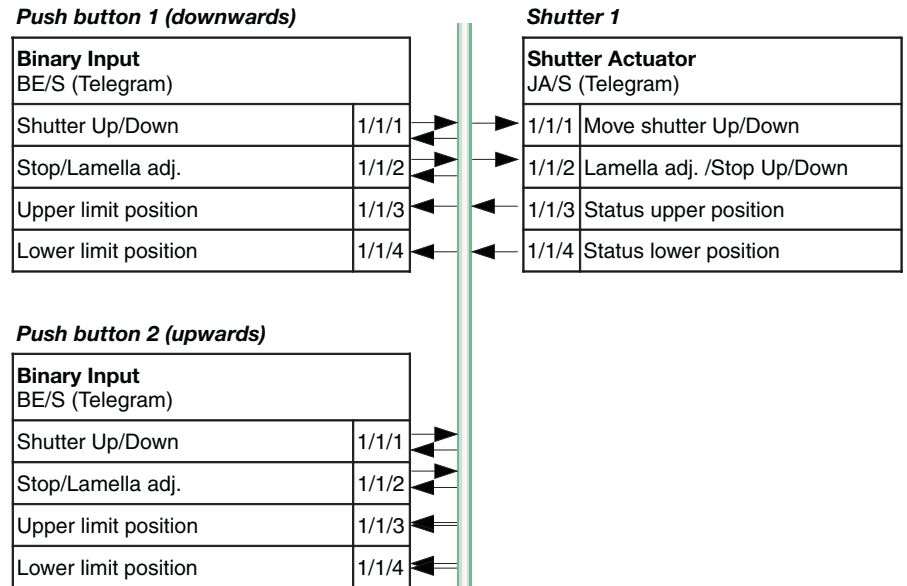
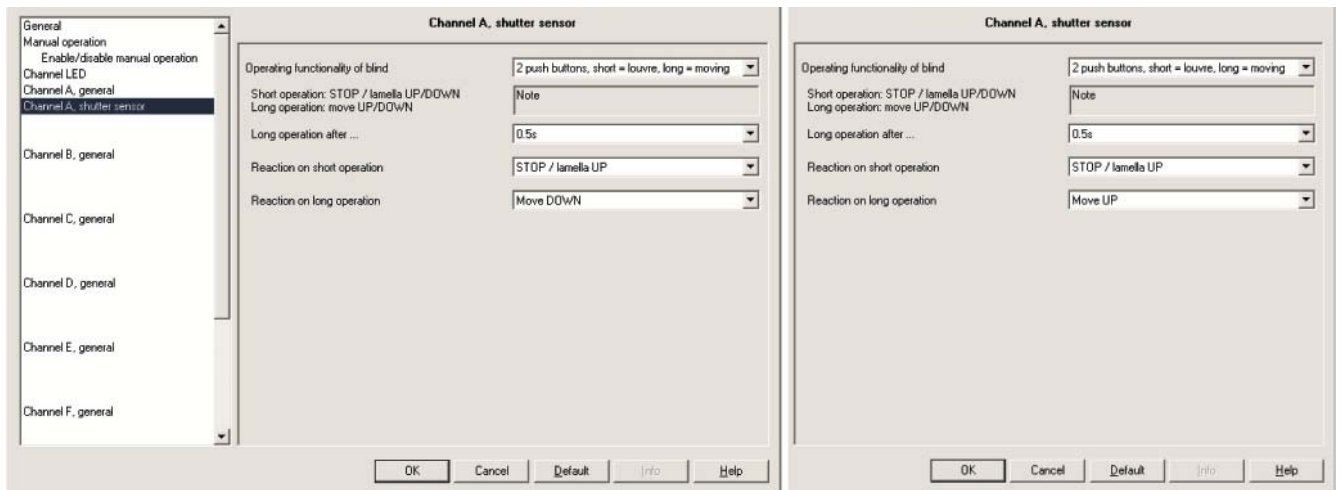

Fig. 90: 2 button operation of shutters

4.5 Scene control

Scene via 6 separate objects

Button 1 and button 2 control shutter 1 and light 1. Short operation calls up the scene. With each operation the current shutter setting and the brightness value are saved. Both buttons save different scene values.

Linking the group addresses:

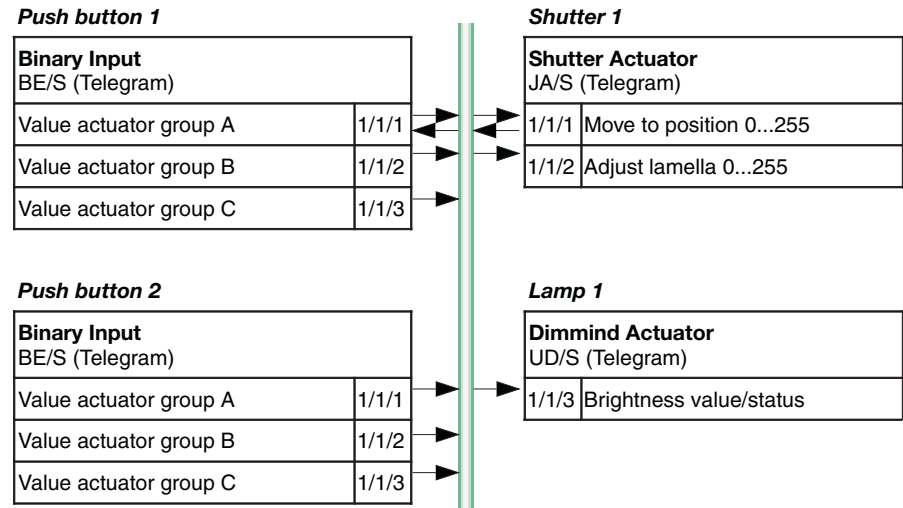

Fig. 91: 2 button operation with central function

Parameter settings for button 1 and button 2:



Fig. 92: Control scene

4.6 Switching sequence (switching of luminaries)

Switching on/off in succession

Button 1 and button 2 control a light with three independent power circuits, Light 1, Light 2 and Light 3. Button 1 switches on in succession when actuated (Sequence: Light 1 > Light 2 > Light 3). Button 2 switches off in succession when actuated (Sequence: Light 3 > Light 2 > Light 1).

Linking the group addresses:

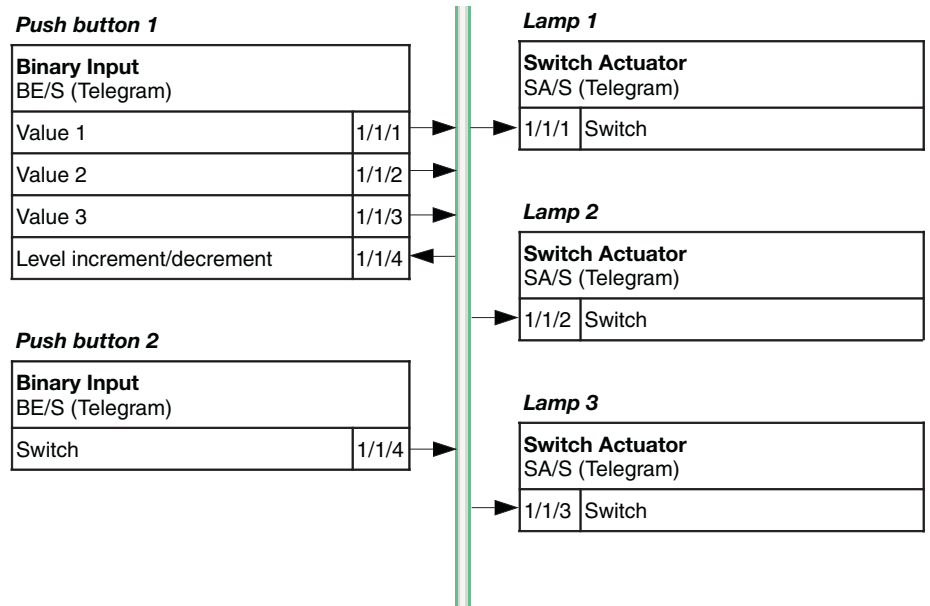

Fig. 93: Switching sequence (switching of illumination with 2 buttons)

Parameter settings for button 1:

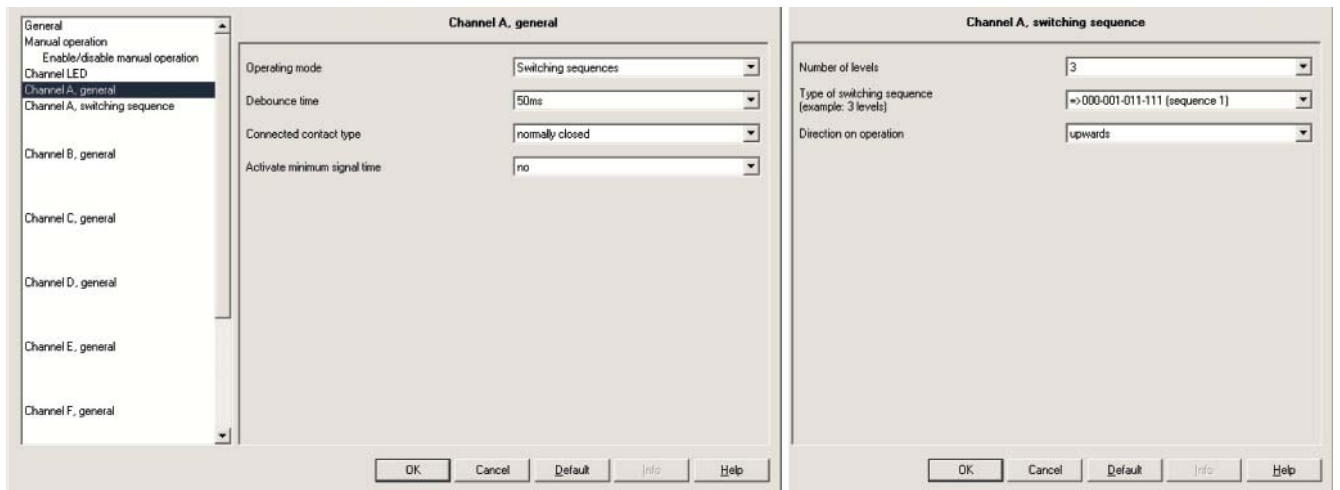

Fig. 94: Switching sequence (switching of luminaires)

Button 2 must be set so that the “Switch” communication object sends a “0” with each button operation.

Switch all possibilities (“Gray code”)

Button 1 controls a light with two independent circuits - Light 1 and Light 2. After operation all possibilities are switched through in the following sequence:

	<i>Light 1</i>	<i>Light 2</i>
Output state	OFF	OFF
1st operation	ON	OFF
2nd operation	ON	ON
3rd operation	OFF	ON
4th operation	OFF	OFF
... (and so further)		

Table 48: Multiple operation with Gray code

Linking the group addresses:

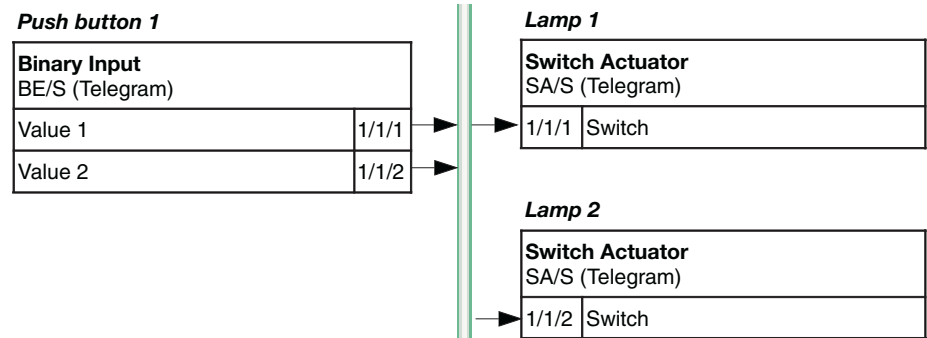

Fig. 95: Switching sequence (switching of illumination with a button)

Parameter settings for button 1:

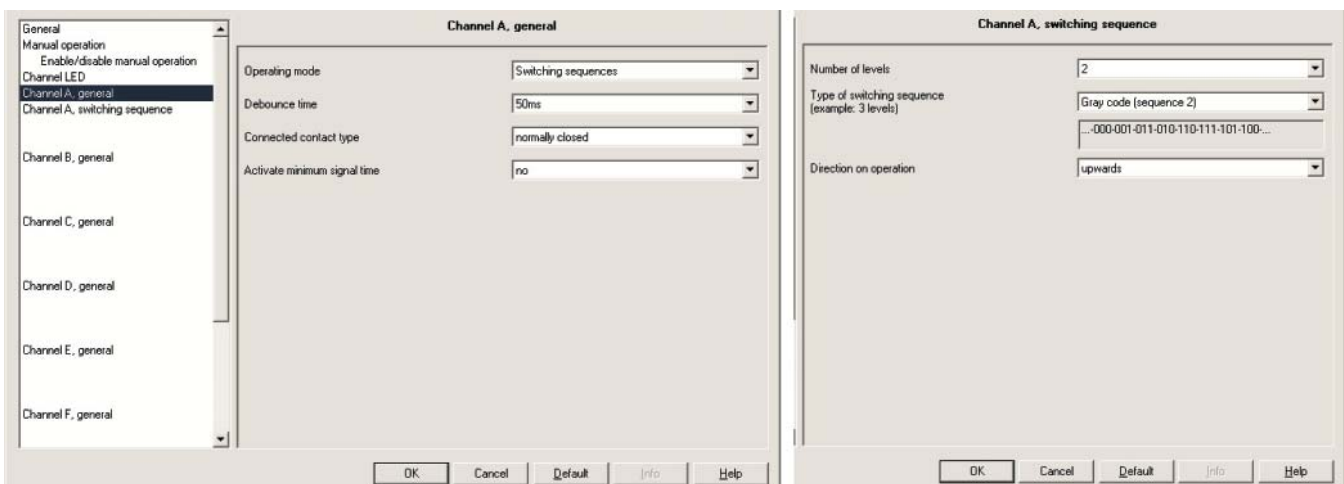

Fig. 96: Switching sequence (switching of illumination) with “Gray code”

4.7 Multiple button operation (switching of luminaires)

Button 1 and button 2 control light 1, light 2 and light 3. With a single button operation Light 1 is switched over, with double button operation Light 2 is switched over and with triple button operation Light 3 is switched over. With a long button push Light 1, Light 2 and Light 3 are switched off.

Linking the group addresses:

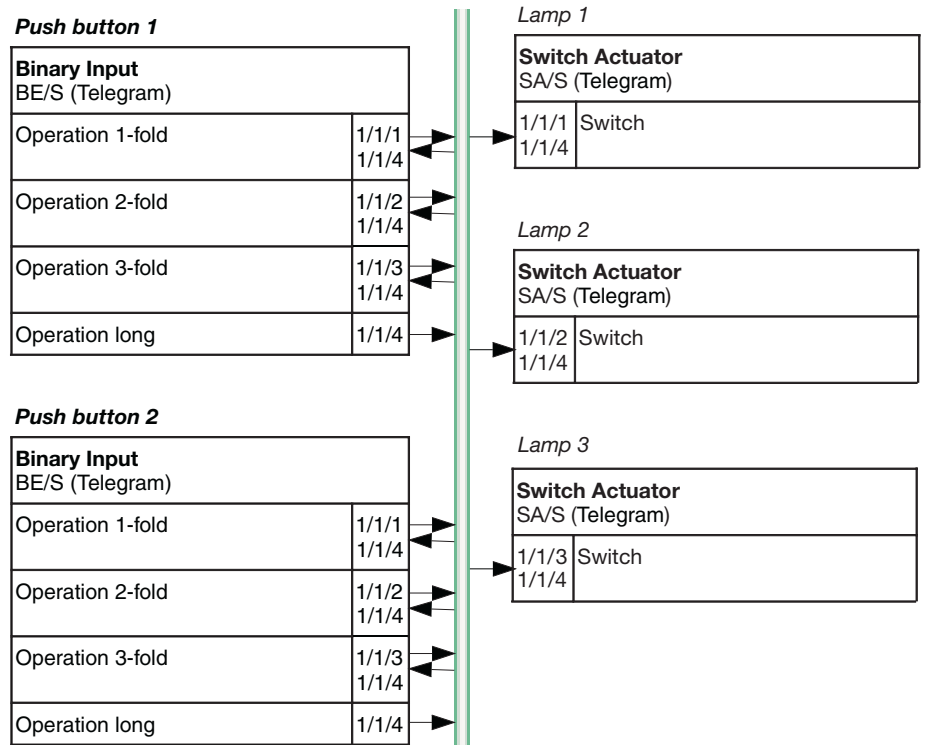

Fig. 97: Multiple button operation (switching of illumination with 2 buttons)

Parameter settings for button 1 and button 2:

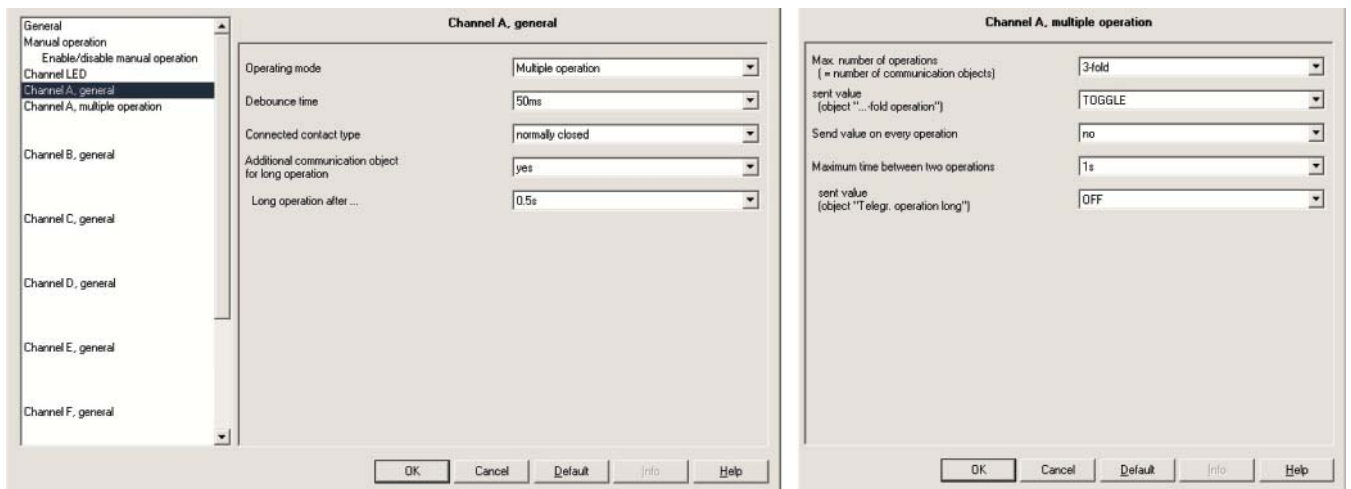

Fig. 98: Multiple button operation (switching of luminaries)

4.8 Counting power values

Input 1 is connected to the S0 pulse output of an energy consumption meter from ABB (100 pulses/kWh). The 4-Byte counter value is represented in the bus in Wh units. It is sent on the bus every 30 seconds and after each change of 100 Wh.

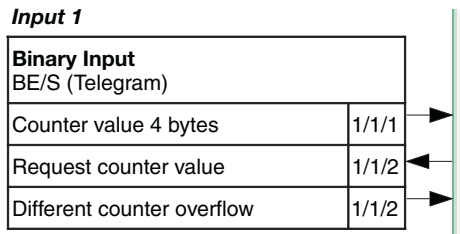

Fig. 99: Counting values

Parameter settings for button1:

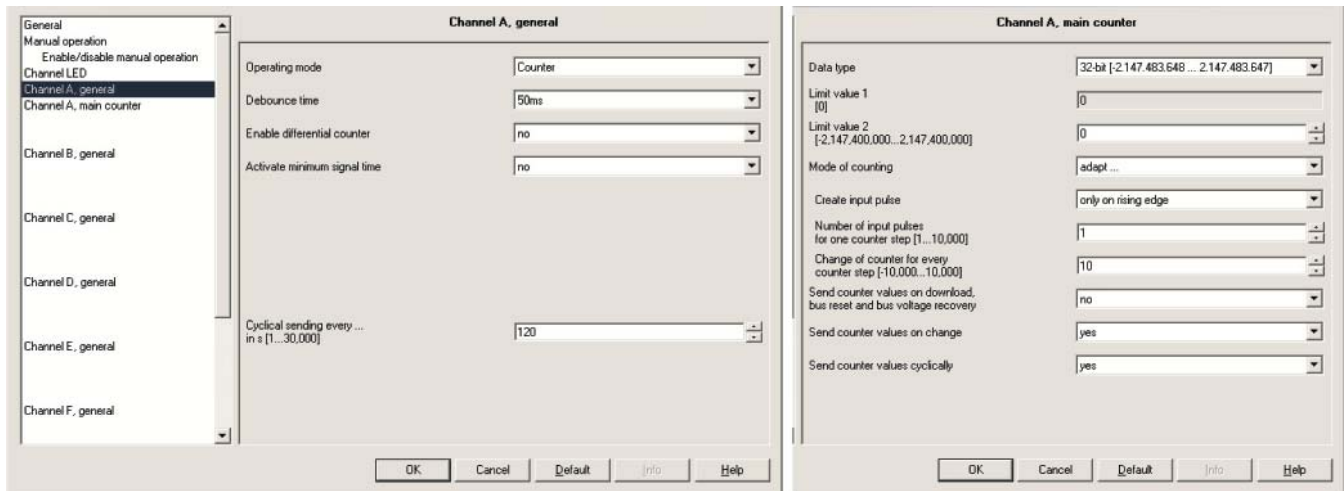

Fig. 100: Counting of power values

100 pulses per kWh mean 1 pulse per 10 Wh. The counter is therefore incremented by a value of 10 with each pulse (factor = 10).

The differential counter overruns every 100 Wh. With each overrun the communication object “Differential counter overrun” is sent with the value “1”. This is received by the “Request counter value” communication object and the current counter state is sent on the bus.

A Appendix

A.1 Scope of delivery

The Binary Inputs are supplied with the following parts. Please check the items received using the following list.

- 1 pc. BE/S x.x.1, Binary Input, xfold, MDRC
- 1 pc. Installation and operating instructions
- 1 pc. Bus connection terminal (red/black)

A.2 4-Bit dimming command

The following table describes the 4 bit dimming command:

Dec.	Hex.	Binary	Dim command
0	0	0000	STOP
1	1	0001	100 % DARKER
2	2	0010	50 % DARKER
3	3	0011	25 % DARKER
4	4	0100	12.5 % DARKER
5	5	0101	6.25 % DARKER
6	6	0110	3.13 % DARKER
7	7	0111	1.56 % DARKER
8	8	1000	STOP
9	9	1001	100 % BRIGHTER
10	A	1010	50 % BRIGHTER
11	B	1011	25 % BRIGHTER
12	C	1100	12.5 % BRIGHTER
13	D	1101	6.25 % BRIGHTER
14	E	1110	3.13 % BRIGHTER
15	F	1111	1.56 % BRIGHTER

Table 48: 4-Bit dimming command

A.3 Gray code

The switching sequence is characterised by the fact that only one value is changed between two levels. The transition to the next level therefore only requires the sending of a single telegram.

The following table describes the gray code when using 5 objects:

Switching level		Value of the communication objects				
No.	Short code.	“Value5”	“Value4”	“Value3”	“Value2”	“Value1”
0	00000	OFF	OFF	OFF	OFF	OFF
1	00001	OFF	OFF	OFF	OFF	ON
2	00011	OFF	OFF	OFF	ON	ON
3	00010	OFF	OFF	OFF	ON	OFF
4	00110	OFF	OFF	ON	ON	OFF
5	00111	OFF	OFF	ON	ON	ON
6	00101	OFF	OFF	ON	OFF	ON
7	00100	OFF	OFF	ON	OFF	OFF
8	01100	OFF	ON	ON	OFF	OFF
9	01101	OFF	ON	ON	OFF	ON
10	01111	OFF	ON	ON	ON	ON
11	01110	OFF	ON	ON	ON	OFF
12	01010	OFF	ON	OFF	ON	OFF
13	01011	OFF	ON	OFF	ON	ON
14	01001	OFF	ON	OFF	OFF	ON
15	01000	OFF	ON	OFF	OFF	OFF
16	11000	ON	ON	OFF	OFF	OFF
17	11001	ON	ON	OFF	OFF	ON
18	11011	ON	ON	OFF	ON	ON
19	11010	ON	ON	OFF	ON	OFF
20	11110	ON	ON	ON	ON	OFF
21	11111	ON	ON	ON	ON	ON
22	11101	ON	ON	ON	OFF	ON
23	11100	ON	ON	ON	OFF	OFF
24	10100	ON	OFF	ON	OFF	OFF
25	10101	ON	OFF	ON	OFF	ON
26	10111	ON	OFF	ON	ON	ON
27	10110	ON	OFF	ON	ON	OFF
28	10010	ON	OFF	OFF	ON	OFF
29	10011	ON	OFF	OFF	ON	ON
30	10001	ON	OFF	OFF	OFF	ON
31	10000	ON	OFF	OFF	OFF	OFF

Table 49: Gray code

A.4 8-bit-scene key table

Bit-no	7	6	5	4	3	2	1	0	Scene number	Recall (R)/ Store (S)
0	00	0	0	0	0	0	0	0	1	A
1	01	0	0	0	0	0	0	1	2	A
2	02	0	0	0	0	0	1	0	3	A
3	03	0	0	0	0	0	1	1	4	A
4	04	0	0	0	0	1	0	0	5	A
5	05	0	0	0	0	1	0	1	6	A
6	06	0	0	0	0	1	1	0	7	A
7	07	0	0	0	0	1	1	1	8	A
8	08	0	0	0	1	0	0	0	9	A
9	09	0	0	0	1	0	0	1	10	A
10	0A	0	0	0	1	0	1	0	11	A
11	0B	0	0	0	1	0	1	1	12	A
12	0C	0	0	0	1	1	0	0	13	A
13	0D	0	0	0	1	1	0	1	14	A
14	0E	0	0	0	1	1	1	0	15	A
15	0F	0	0	0	1	1	1	1	16	A
16	10	0	0	1	0	0	0	0	17	A
17	11	0	0	1	0	0	0	1	18	A
18	12	0	0	1	0	0	1	0	19	A
19	13	0	0	1	0	0	1	1	20	A
20	14	0	0	1	0	1	0	0	21	A
21	15	0	0	1	0	1	0	1	22	A
22	16	0	0	1	0	1	1	0	23	A
23	17	0	0	1	0	1	1	1	24	A
24	18	0	0	1	1	0	0	0	25	A
25	19	0	0	1	1	0	0	1	26	A
26	1A	0	0	1	1	0	1	0	27	A
27	1B	0	0	1	1	0	1	1	28	A
28	1C	0	0	1	1	1	0	0	29	A
29	1D	0	0	1	1	1	0	1	30	A
30	1E	0	0	1	1	1	1	0	31	A
31	1F	0	0	1	1	1	1	1	32	A
32	20	0	0	1	0	0	0	0	33	A
33	21	0	0	1	0	0	0	1	34	A
34	22	0	0	1	0	0	1	0	35	A
35	23	0	0	1	0	0	1	1	36	A
36	24	0	0	1	0	1	0	0	37	A
37	25	0	0	1	0	1	0	1	38	A
38	26	0	0	1	0	1	1	0	39	A
39	27	0	0	1	0	1	1	1	40	A
40	28	0	0	1	0	1	0	0	41	A
41	29	0	0	1	0	1	0	1	42	A
42	2A	0	0	1	0	1	0	1	43	A
43	2B	0	0	1	0	1	0	1	44	A
44	2C	0	0	1	0	1	1	0	45	A
45	2D	0	0	1	0	1	1	0	46	A
46	2E	0	0	1	0	1	1	1	47	A
47	2F	0	0	1	0	1	1	1	48	A
48	30	0	0	1	1	0	0	0	49	A
49	31	0	0	1	1	0	0	1	50	A
50	32	0	0	1	1	0	0	1	51	A
51	33	0	0	1	1	0	0	1	52	A
52	34	0	0	1	1	0	1	0	53	A
53	35	0	0	1	1	0	1	0	54	A
54	36	0	0	1	1	0	1	1	55	A
55	37	0	0	1	1	0	1	1	56	A
56	38	0	0	1	1	1	0	0	57	A
57	39	0	0	1	1	1	0	0	58	A
58	3A	0	0	1	1	1	0	1	59	A
59	3B	0	0	1	1	1	0	1	60	A
60	3C	0	0	1	1	1	1	0	61	A
61	3D	0	0	1	1	1	1	0	62	A
62	3E	0	0	1	1	1	1	0	63	A
63	3F	0	0	1	1	1	1	1	64	A
128	80	1	0	0	0	0	0	0	1	S
129	81	1	0	0	0	0	0	1	2	S
130	82	1	0	0	0	0	0	1	3	S
131	83	1	0	0	0	0	0	1	4	S
132	84	1	0	0	0	0	1	0	5	S
133	85	1	0	0	0	0	1	0	6	S
134	86	1	0	0	0	0	1	1	7	S
135	87	1	0	0	0	0	1	1	8	S
136	88	1	0	0	0	1	0	0	9	S
137	89	1	0	0	0	1	0	0	10	S
138	8A	1	0	0	0	1	0	1	11	S
139	8B	1	0	0	0	1	0	1	12	S
140	8C	1	0	0	0	1	1	0	13	S
141	8D	1	0	0	0	1	1	0	14	S
142	8E	1	0	0	0	1	1	1	15	S
143	8F	1	0	0	0	1	1	1	16	S

144	90	1	0	0	1	0	0	0	0	17	S
145	91	1	0	0	1	0	0	0	1	18	S
146	92	1	0	0	1	0	0	1	0	19	S
147	93	1	0	0	1	0	0	1	1	20	S
148	94	1	0	0	1	0	1	0	0	21	S
149	95	1	0	0	1	0	1	0	1	22	S
150	96	1	0	0	1	0	1	1	0	23	S
151	97	1	0	0	1	0	1	1	1	24	S
152	98	1	0	0	1	1	0	0	0	25	S
153	99	1	0	0	1	1	0	0	1	26	S
154	9A	1	0	0	1	1	0	1	0	27	S
155	9B	1	0	0	1	1	0	1	1	28	S
156	9C	1	0	0	1	1	1	0	0	29	S
157	9D	1	0	0	1	1	1	0	1	30	S
158	9E	1	0	0	1	1	1	1	0	31	S
159	9F	1	0	0	1	1	1	1	1	32	S
160	A0	1	0	1	0	0	0	0	0	33	S
161	A1	1	0	1	0	0	0	0	1	34	S
162	A2	1	0	1	0	0	0	1	0	35	S
163	A3	1	0	1	0	0	0	1	1	36	S
164	A4	1	0	1	0	0	1	0	0	37	S
165	A5	1	0	1	0	0	1	0	1	38	S
166	A6	1	0	1	0	0	1	1	0	39	S
167	A7	1	0	1	0	0	1	1	1	40	S
168	A8	1	0	1	0	1	0	0	0	41	S
169	A9	1	0	1	0	1	0	0	1	42	S
170	AA	1	0	1	0	1	0	1	0	43	S
171	AB	1	0	1	0	1	0	1	1	44	S
172	AC	1	0	1	0	1	1	0	0	45	S
173	AD	1	0	1	0	1	1	0	1	46	S
174	AE	1	0	1	0	1	1	1	0	47	S
175	AF	1	0	1	0	1	1	1	1	48	S
176	B0	1	0	1	1	0	0	0	0	49	S
177	B1	1	0	1	1	0	0	0	1	50	S
178	B2	1	0	1	1	0	0	1	0	51	S
179	B3	1	0	1	1	0	0	1	1	52	S
180	B4	1	0	1	1	0	1	0	0	53	S
181	B5	1	0	1	1	0	1	0	1	54	S
182	B6	1	0	1	1	0	1	1	0	55	S
183	B7	1	0	1	1	0	1	1	1	56	S
184	B8	1	0	1	1	1	0	0	0	57	S
185	B9	1	0	1	1	1	0	0	1	58	S
186	BA	1	0	1	1	1	0	1	0	59	S
187	BB	1	0	1	1	1	0	1	1	60	S
188	BC	1	0	1	1	1	1	0	0	61	S
189	BD	1	0	1	1	1	1	0	1	62	S
190	BE	1	0	1	1	1	1	1	0	63	S
191	BF	1	0	1	1	1	1	1	1	64	S

A.5	Directory of drawings		
		Fig. 1:	BE/S 4.230.1 6
		Fig. 2:	Circuit diagram of BE/S 4.230.1 7
		Fig. 3:	Dimension drawing BE/S 4.230.1 7
		Fig. 4:	BE/S 4.24.1 9
		Fig. 5:	Circuit diagram of BE/S 4.24.1 10
		Fig. 6:	Dimension drawing BE/S 4.24.1 10
		Fig. 7:	BE/S 4.20.1 12
		Fig. 8:	Circuit diagram of BE/S 4.20.1 13
		Fig. 9:	Dimension drawing BE/S 4.20.1 13
		Fig. 10:	BE/S 8.230.1 15
		Fig. 11:	Circuit diagram of BE/S 8.230.1 16
		Fig. 12:	Dimension drawing BE/S 8.230.1 16
		Fig. 13:	BE/S 8.24.1 18
		Fig. 14:	Circuit diagram of BE/S 8.24.1 19
		Fig. 15:	Dimension drawing BE/S 8.24.1 19
		Fig. 16:	BE/S 8.20.1 21
		Fig. 17:	Circuit diagram of BE/S 8.20.1 22
		Fig. 18:	Dimension drawing BE/S 8.20.1 22
		Fig. 19:	Conversion of previous application programs 25
		Fig. 20:	Parameter window "General" 26
		Fig. 21:	Behaviour after voltage recovery 27
		Fig. 22:	Parameter window "Manual Operation" 29
		Fig. 23:	Parameter window "Enable/release manual operation" 32
		Fig. 24:	Parameter window "Channel LED display" 33
		Fig. 25:	Communication objects "General" 34
		Fig. 26:	Parameter window "Channel A, general" 35
		Fig. 27:	Parameter window "Channel A, general" switch sensor operating mode 36
		Fig. 28:	Debounce time of the input signal on the edge to be recognised 36
		Fig. 29:	Distinction between short/long operation of the "Switch sensor" function 37
		Fig. 30:	Minimum signal time of the input signal on the edge to be recognised 38
		Fig. 31:	Parameter window "Channel A, general" switch sensor operating mode 39
		Fig. 32:	Parameter window "Channel A, switch sensor" operating mode 40
		Fig. 33:	Parameter window "Channel A, switch sensor" operating mode 42
		Fig. 34:	Parameter window "Channel A, general" fault signal input operating mode 43
		Fig. 35:	Debounce time of the input signal on the edge to be recognised 44
		Fig. 36:	Distinction between short/long operation of the "Switch sensor" function 44
		Fig. 37:	Minimum signal time of the input signal on the edge to be recognised 45
		Fig. 38:	Behaviour after voltage recovery with inactive wait state 46
		Fig. 39:	Parameter window "Channel A, switch sensor" operating mode for a fault signal input 48
		Fig. 40:	Communication objects "Channel A" switch sensor operating mode 50
		Fig. 41:	Parameter window "Channel A, general" switch/dimming sensor operating mode 52
		Fig. 42:	Debounce time of the input signal on the edge to be recognised 52
		Fig. 43:	Parameter window "Channel A, switch/dimming sensor" operating mode 53
		Fig. 44:	Communication objects "Channel A" switch/dimming sensor operating mode 56
		Fig. 45:	Parameter window "Channel A, general" shutter sensor operating mode 58
		Fig. 46:	Debounce time of the input signal on the edge to be recognised 58
		Fig. 47:	Parameter window "Channel A, shutter sensor" operating mode 59
		Fig. 48:	Communication objects "Channel A" shutter sensor operating mode 62
		Fig. 49:	Parameter window "Channel A, general" value/forced operation operating mode 64
		Fig. 50:	Debounce time of the input signal on the edge to be recognised 64
		Fig. 51:	Distinction between short/long operation for "Value/forced operation" function 65
		Fig. 52:	Minimum signal time of the input signal on the edge to be recognised 66
		Fig. 53:	Parameter window "Channel A, general" value/forced operation operating mode 68
		Fig. 54:	Parameter window "Channel A, value/forced operation value 1" operating mode 69
		Fig. 55:	Communication objects "Channel A" value/forced operation operating mode 71
		Fig. 56:	Parameter window "Channel A, general" control scene operating mode 74
		Fig. 57:	Debounce time of the input signal on the edge to be recognised 74
		Fig. 58:	Parameter window "Channel A, scene part 1" operating mode 76
		Fig. 59:	Communication objects "Channel A" scene control operating mode 77
		Fig. 60:	Parameter window "Channel A, general" switching sequence operating mode 80
		Fig. 61:	Debounce time of the input signal on the edge to be recognised 80
		Fig. 62:	Minimum signal time of the input signal on the edge to be recognised 81
		Fig. 63:	Parameter window "Channel A, switch sequence" operating mode 82
		Fig. 64:	Communication objects "Channel A" switching sequence operating mode 85

Fig. 65:	Parameter window "Channel A, general" multiple operation operating mode	87
Fig. 66:	Debounce time of the input signal on the edge to be recognised	87
Fig. 67:	Parameter window "Channel A, multiple operation" operating mode	89
Fig. 68:	Communication objects "Channel A" multiple operation operating mode	91
Fig. 69:	Pulse count function	93
Fig. 70:	Parameter window "Channel A, general" counter operating mode	95
Fig. 71:	Debounce time of the input signal on the edge to be recognised	95
Fig. 72:	Minimum signal time of the input signal on the edge to be recognised	96
Fig. 73:	Parameter window "Channel A, main counter" counter operating mode	97
Fig. 74:	Parameter window "Channel A, differential counter" counter operating mode	99
Fig. 75:	Communication objects "Channel A, main counter" counter operating mode	102
Fig. 76:	Communication objects "Channel A main and differential counter" counter operating mode	104
Fig. 77:	2 button operation with central function	107
Fig. 78:	1 button operation with central function	107
Fig. 79:	Parameter window "General" fault signal input	108
Fig. 80:	Parameter window "Manual Operation" fault signal input	108
Fig. 81:	Fault signal input parameter window "Enable/release manual operation button"	109
Fig. 82:	Fault signal input parameter window "Channel LED display"	109
Fig. 83:	Fault signal input parameter window "Channel A, general"	110
Fig. 84:	Fault signal input parameter window "Channel A, switch sensor"	110
Fig. 85:	2 button operation of lighting (dim lighting)	111
Fig. 86:	1 button operation of lighting (dim lighting)	111
Fig. 87:	2 button operation of shutters	112
Fig. 88:	1 button operation of shutters	112
Fig. 89:	2 button operation of shutter button 1 and 2	113
Fig. 90:	2 button operation of shutters	113
Fig. 91:	2 button operation with central function	114
Fig. 92:	Control scene	114
Fig. 93:	Switching sequence (switching of illumination with 2 buttons)	115
Fig. 94:	Switching sequence (switching of luminaires)	115
Fig. 95:	Switching sequence (switching of illumination with one button)	116
Fig. 96:	Switching sequence (switching of illumination) with "Gray code"	116
Fig. 97:	Multiple button operation (switching of illumination with 2 buttons)	117
Fig. 98:	Switching sequence (switching of luminaires)	117
Fig. 99:	Counting values	118
Fig. 100:	Counting of power values	118

A.6 Directory of tables

Table 1:	Technical data BE/S 4.230.1	6
Table 2:	Application program BE/S 4.230.1	7
Table 3:	Technical data BE/S 4.24.1	9
Table 4:	Application program BE/S 4.24.1	10
Table 5:	Technical data BE/S 4.20.1	12
Table 6:	Application program BE/S 4.20.1	13
Table 7:	Technical data BE/S 8.230.1	15
Table 8:	Application program BE/S 8.230.1	16
Table 9:	Technical data BE/S 8.24.1	18
Table 10:	Application program BE/S 8.24.1	19
Table 11:	Technical data BE/S 8.20.1	21
Table 12:	Application program BE/S 8.20.1	22
Table 13:	Functions of the application program	24
Table 14:	Functions of the application program	25
Table 15:	Behaviour after voltage recovery	27
Table 16:	Communication objects "General" 0 to 9	34
Table 17:	Communication objects 10 to 19 "Channel A" switch sensor operating mode	50
Table 18:	Communication objects 20 to 89 "Channel B to H" switch sensor operating mode	51
Table 19:	Dimming function "1 button dimming"	53
Table 20:	4 bit dim command for start-stop dimming	55
Table 21:	Communication objects 10 to 19 "Channel A" switch/dimming sensor operating mode	56
Table 22:	Communication objects 20 to 89 "Channel B to H" switch/dimming sensor operating mode	57
Table 23:	Various shutter operating functions	60
Table 24:	Communication objects 10 to 19 "Channel A" shutter sensor operating mode	62
Table 25:	Communication objects 20 to 89 "Channel B to H" shutter sensor operating mode	63
Table 26:	Operating mode value/forced operation priority object	70
Table 27:	Communication objects 10 to 19 "Channel A" value/forced operation operating mode	71
Table 28:	Communication objects 20 to 89 "Channel B to H" value/forced operation operating mode	72
Table 29:	Communication objects 10 to 13 "Channel A" scene control operating mode	77
Table 30:	Communication objects 14 to 19 "Channel A" scene control operating mode	78
Table 31:	Communication objects 20 to 89 "Channel B to H" control scene operating mode	79
Table 32:	Switching sequence 1	83
Table 33:	Switching sequence 3	83
Table 34:	Switching sequence 4	84
Table 35:	Switching sequence 5	84
Table 36:	Communication objects 10 to 15 "Channel A" switching sequence operating mode	85
Table 37:	Communication objects 16 to 19 "Channel A" switching sequence operating mode	86
Table 38:	Communication objects 20 to 89 "Channel B to H" switching sequence operating mode	86
Table 39:	Communication objects 10 to 19 "Channel A" multiple operation operating mode	91
Table 40:	Communication objects 20 to 89 "Channel B to H" multiple operation operating mode	92
Table 41:	Peculiarities between the main counter and differential counter	94
Table 42:	Communication objects 13 to 19 "Channel A, main counter" counter operating mode	102
Table 43:	Communication objects 20 to 89 "Channel B to H main counter" counter operating mode	103
Table 44:	Communication objects 10 to 12 counter operating mode "Channel A main and differential counter"	104
Table 45:	Communication objects 13 to 19 counter operating mode "Channel A main and differential counter"	105
Table 46:	Communication objects 20 to 89 counter operating mode "Channel B to H main and differential counter"	106
Table 47:	Multiple operation with Gray code	116
Table 48:	4-Bit dimming command	I
Table 49:	Gray code	II
Table 50:	Ordering details, Binary Inputs, xfold, MDRC	VIII

A.7 Index

1 button dimming	53
2 button dimming	54
8 bit scene	70
Assignment of physical addresses	5, 6, 8, 9, 11, 12, 14, 15, 17, 18, 20, 21, 23
Automatic operation	31
Bus voltage	6, 9, 12, 15, 18, 21
Bus voltage recovery	26, 27, 38, 46, 66, 67, 99, 101
Channel LED display	32
Cleaning	8, 11, 14, 17, 20, 23
Commissioning requirements	8, 11, 14, 17, 20, 23
Cyclical sending	41, 49, 96
Debounce time	36, 43, 44, 52, 58, 64, 74, 80, 87, 95
Dimming mode	55
Enable/release manual operation button	32
Fault messages	32, 33
Floating contacts	12, 21
Inputs	6, 9, 12, 15, 18, 21
Maintenance	8, 11, 14, 17, 20, 23
Manual operation	29, 30, 31
Minimum signal time	37, 38, 45, 66, 67, 81, 96
Observation period	28
Operating mode	35
Power supply	6, 9, 12, 15, 18, 21
Programming	4, 7, 8, 10, 11, 13, 14, 16, 17, 19, 20, 22, 23, 24, 27
Scene	70
Supplied state	8, 11, 14, 17, 20, 23
Telegram rate limitation	28

A.8 Ordering information

Designation	Ordering information Short description	Order No.	bbn 40 16779 EAN	Price group	Weight 1 pc. in kg	Pack unit [Pc.]
Binary Input, 4-fold, 230 V AC/DC, MDRC	BE/S 4.230.1	2CDG 110 051 R0011	63044 3	26	0.1	1
Binary Input, 4-fold, 24 V AC/DC, MDRC	BE/S 4.24.1	2CDG 110 052 R0011	63045 0	26	0.1	1
Binary Input, 4-fold, 20 V, MDRC, contact scanning	BE/S 4.20.1	2CDG 110 053 R0011	63037 5	26	0.1	1
Binary Input, 8-fold, 230 V AC/DC, MDRC	BE/S 8.230.1	2CDG 110 054 R0011	63041 2	26	0.2	1
Binary Input, 8-fold, 24 V AC/DC, MDRC	BE/S 8.24.1	2CDG 110 055 R0011	63042 9	26	0.2	1
Binary Input, 8-fold, 20 V, MDRC, contact scanning	BE/S 8.20.1	2CDG 110 056 R0011	63043 6	26	0.2	1

Table 50: Ordering details, Binary Inputs, xfold, MDRC

A.9 Notes

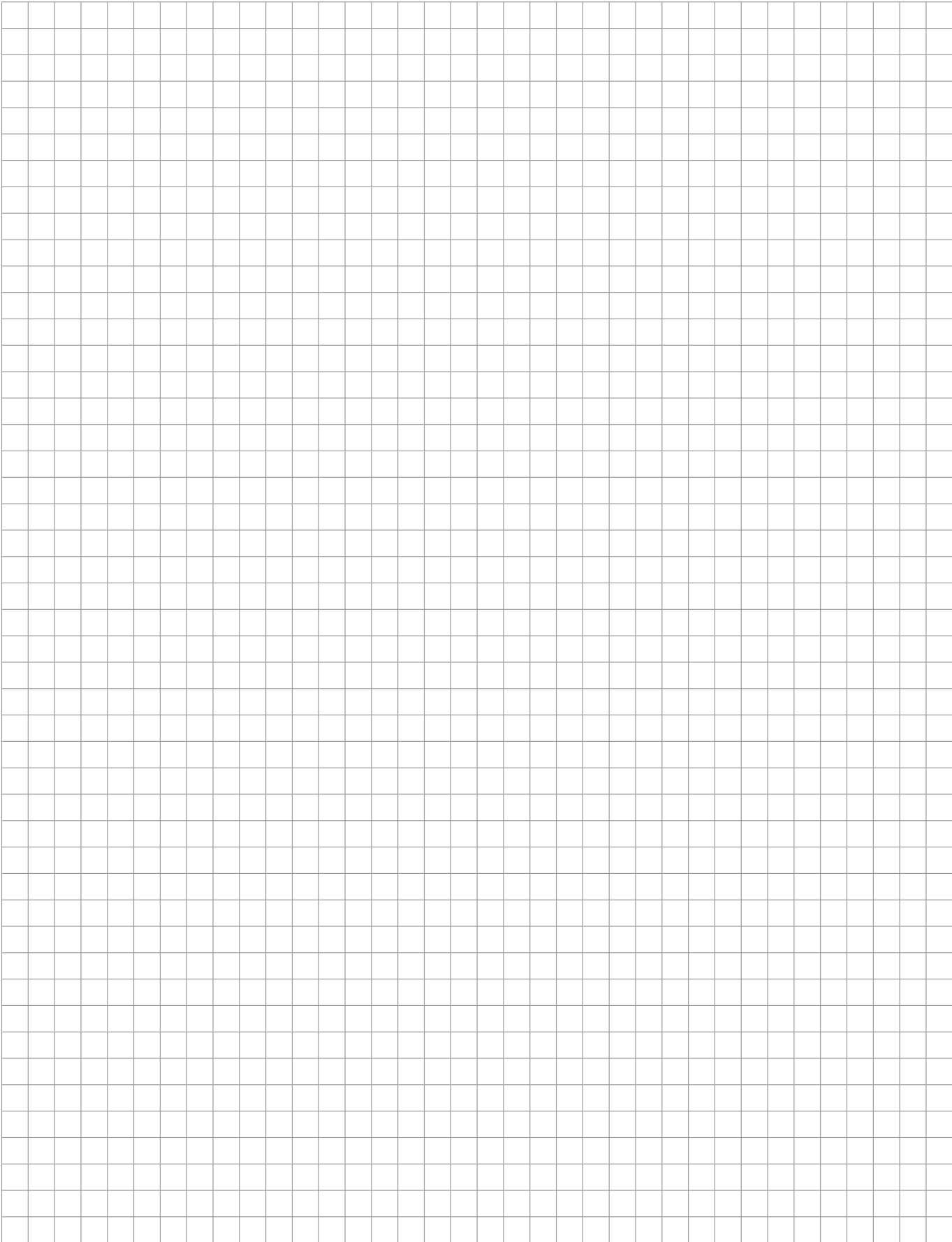





The information in this leaflet is subject to change without further notice.

Your EIB-Partner